



G O M A X[®]

**GENERAL
CATALOGUE**

Thermoplastic hoses and fittings for AC&R



QUADRA:

PLASTIC CAPILLARY HOSE

The market leading brand of thermoplastic hose and fittings designed specifically for Air Conditioning and Refrigeration systems. The preferred flexible choice for all pressure switch, manometer and oil line connections.



INFINITY

PLASTIC VIBRATION ABSORBER

Thermoplastic and vibration-proof for air conditioning and refrigeration systems





ZERO

PLASTIC CONVOLUTED HOSE

The range of assembled hoses for air conditioning and refrigeration, tailor made for every needs.

INDEX

The Company	pag. 4
 QUADRA	pag. 6
The QUADRA system	pag. 8
QUADRA elements	pag. 9
Visual index	pag. 12
QUADRA DN2	pag. 14
Application	pag. 14
Technical data	pag. 16
QUADRA DN2 fittings	pag. 17
Accessories for QUADRA DN2 hoses	pag. 23
QUADRA DN2 assembled capillary hoses	pag. 24
QUADRA DN4	pag. 31
Application	pag. 31
Technical data	pag. 32
QUADRA DN4 fittings	pag. 33
QUADRA reusable fittings	pag. 37
Accessories for QUADRA DN4 hoses	pag. 38
QUADRA DN4 assembled capillary hoses	pag. 39

QUADRA DN6	pag. 44
Application	pag. 44
Technical data	pag. 46
QUADRA DN6 fittings	pag. 47
QUADRA DN6 assembled capillary hoses	pag. 50
QUADRA Crimp	pag. 52
QUADRA Packages	pag. 54
Accessories for QUADRA hoses	pag. 56
 INFINITY	pag. 58
Technical data	pag. 62
 ZERO	pag. 68
Technical data	pag. 72
Thermoplastic hose installation factors	pag. 74
General terms of sale	pag. 76

Extra care is taken in the preparation of this catalogue, but Transfer Oil S.p.A. is not responsible for any inadvertent typographical errors or omissions. Information subject to change without notice. The information in this catalogue is only accurate as of the date of publication. Transfer Oil S.p.A. assume no liability on mistakes nor errors appearing in catalogues, releases or other documents. Transfer Oil reserve the right to change his products without any previous notice. These changes might be made on purchased products provided. Transfer Oil, the TO logo and Gomax logo are registered trademarks. No use is allowed without Transfer Oil written approval.



G O M A X[®]

a brand of

TRANSFER OIL

The Company

Transfer Oil first made its entrance into the flexible thermoplastic hose market in 1979, quickly reaching a leadership position in Europe through the use of avant-garde research and production tools.

In fact in 1993 it was the first company in its field to obtain the ISO 9001 certification. Transfer Oil's role in the international marketplace grew rapidly, and the establishment of the Gomax line gave way to the separate division dedicated specifically to representing refrigeration and air conditioning products.

Transfer Oil teamed up with a number of partners facilitating the production of the first flexible thermoplastic hoses replacing the traditional metal pipes.

In 1995 the international brand Gomax was officially launched, including the Zero, Infinity and Quadra lines.



Thanks to the decision to follow the path of research and quality innovation Transfer Oil offers avant-garde solutions to today's international markets.

Transfer Oil ensures quality by using specific equipment to check the incoming materials in its sophisticated laboratories. The laboratories carry out viscosity index analyses needed to forecast the behaviour of the materials during processing, as well as granular humidity tests.

The careful attention to quality control follows the product throughout all processing phases, thanks to the hard work of the Test Laboratory.

The tests carried out on the finished products are divided into the following: destructive tests, to guarantee the mechanical characteristics such as bursting and assembling tests, and other controls to measure the gas seal, which subject the products to a higher working pressure than that for which they were designed for in order to guarantee maximum reliability. Transfer Oil's collaboration with Milan Polytechnic and the technicians from Perkin Elmer have assured even further progress in the quality analysis and determination of gas permeability, thanks to the combined use of FT-IR spectrophotometer and a custom-made software, which records quantitative information.



**Quality, research
and development**

The market leading brand of thermoplastic hose and fittings designed specifically for Air Conditioning and Refrigeration systems. The preferred flexible choice for all pressure switch, manometer and oil line connections.

QUADRA:



PLASTIC CAPILLARY HOSE

More flexibility

Vibration reduction leading
to reduced noise levels

Simple and fast installation
and maintenance



QUADRA
PLASTIC CAPILLARY HOSE

PLASTIC CAPILLARY HOSE **QUADRA**

PLASTIC CONVOLUTED HOSE **INFINITY**

PLASTIC VIBRATION ABSORBER **ZERO**



THE QUADRA SYSTEM

QUADRA

PLASTIC CAPILLARY HOSE

All QUADRA capillary hoses and fittings (DN2, DN4 and DN6 included), now can be used with CO₂ up to 120 bar / 1740 psi from -45°C up to +130°C / from -49°F up to +266°F, enabling installations onto machines operating in transcritical system.



The Quadra system - comprising of thermoplastic flexible capillary hose, fittings in brass and steel and dedicated tooling - gives quick production, in a few simple steps, with superior quality connections to the pressure test points, gauges, the pressure switches including the oil return circuits and oil level equalization, for air conditioning and refrigeration units of each type and size.

MORE SECURITY:

The use of QUADRA flexible hose eliminates the problems caused by the effect of vibrations that is associated with copper tubing, reducing sound levels and vibration transmission significantly and at the same time eliminating the risk of rupture and leak of refrigerant.

MORE SPEED:

The possibility of choosing between QUADRA hose already assembled at the factory in standard configurations, or to the customers own design, and the flexibility for the customer to be able to make on the spot their own QUADRA hose assemblies in the preferred configuration using the selection of fittings, components and tools part of the QUADRA system, allow to reduce the time required to make circuits when compared to using rigid copper tubing.

MORE SIMPLICITY:

The complete system of fittings, accessories and tooling, the multi lingual instructions and the great intuitiveness of the QUADRA system make the operation of assembly the connections not only faster but, above all, more simple and consequently more secure. In contrast to the brazing or bending operations that are necessary for rigid copper tubing, installation and connection of QUADRA flexible hose does not need any particular specialization and so making the connecting operation within anyone's ability.

The large fitting range available and the dedicated assembly tooling for the QUADRA hose allows the operator to assemble the machine, or carry out maintenance and to work quickly, flexibly and securely, reducing to a minimum or eliminating completely the need of brazing operations.

Directive 2002/95/EC



"Restriction of the use of certain hazardous substances in electrical and electronic equipment"

All QUADRA products meet the minimum requirements of the RoHS directive.

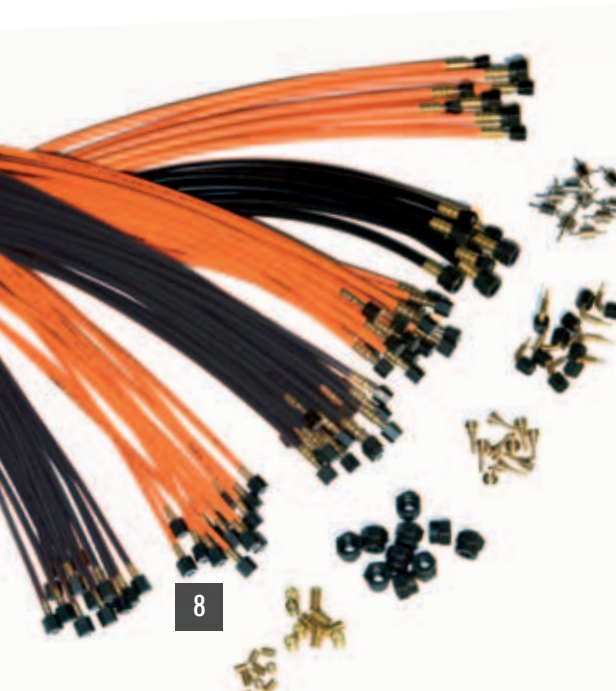

QUADRA ELEMENTS

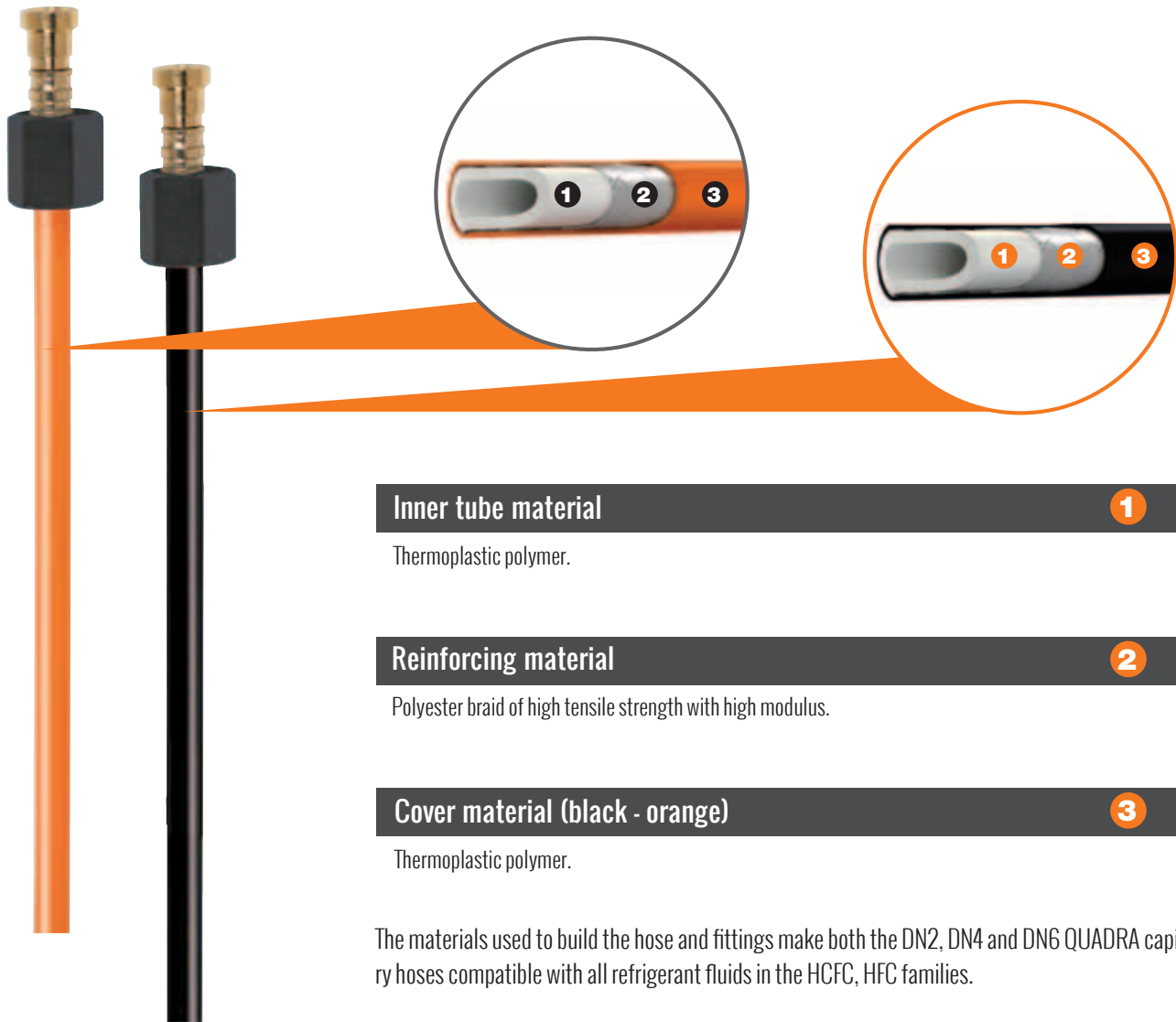

Inner tube material

1

Thermoplastic polymer.

Reinforcing material

2

Polyester braid of high tensile strength with high modulus.

Cover material (black - orange)

3

Thermoplastic polymer.

The materials used to build the hose and fittings make both the DN2, DN4 and DN6 QUADRA capillary hoses compatible with all refrigerant fluids in the HCFC, HFC families.

Meets and exceeds UNI EN 1736 standards.

200 hrs UV TEST

- ▶ The test was made using a specific equipment called "Solar Box ERICHSEN mod. S1D (Xenon Lamp)". The duration of the test has been 200 hours in total.
- ▶ The evaluation is based on the observation of the grey tones of the samples: the samples should not change their grey scale.
- ▶ The evaluation is expressed on a scale from 1 to 5, where 1 is very bad and 5 is excellent.
- ▶ The orange sample achieved rating 4 (good).
- ▶ The black sample achieved rating 5 (excellent).
- ▶ Hence it follows that for all applications where the hoses are exposed to direct and frequent sunlight, black Quadra hoses are to be preferred.

CO₂ SAVER.



QUADRA:

How much CO₂ equivalent, through emissions of HFCs, have you introduced in our environment so far?

We are all requested to decrease CO₂ equivalent emissions of HFCs in order to control the global warming of our planet.

The new QUADRA flexible hose is a "CO₂ EQUIVALENT" SAVER, due to its very low permeability to the majority of the refrigerant gasses **exceeding EN 1736 CLASS 1**, and due to its capacity to reduce system vibrations as well as its simplicity to be installed.



Thermoplastic hoses and fittings for AC&R

Transfer Oil S.p.A. - via sacca, 64 - 43052 - colorno (parma) - italy info@gomax.it - www.gomax.it

Permeability classification according to the European Standard EN 1736:2008 for non metallic tubes used in air conditioning and refrigeration systems

low permeability

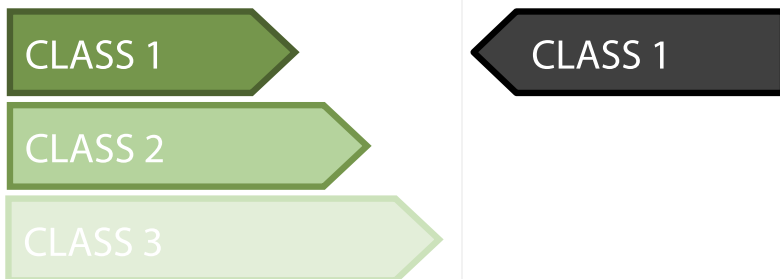

high permeability

TEST DATA		Test temperature		
		+32 °C	+100 °C	
R404A	Test pressure	14.0	60.0	bar
	QUADRA™ DN2 permeability rate	0.12	8.20	g/m ² /year
	QUADRA™ DN4 permeability rate	0.19	9.10	g/m ² /year
	QUADRA™ DN6 permeability rate	0.13	6.50	g/m ² /year
R407C	Test pressure	13.3	60.0	bar
	QUADRA™ DN2 permeability rate	0.11	7.63	g/m ² /year
	QUADRA™ DN4 permeability rate	0.17	8.46	g/m ² /year
	QUADRA™ DN6 permeability rate	0.11	6.05	g/m ² /year
R410A	Test pressure	18.8	60.0	bar
	QUADRA™ DN2 permeability rate	0.14	7.13	g/m ² /year
	QUADRA™ DN4 permeability rate	0.22	7.92	g/m ² /year
	QUADRA™ DN6 permeability rate	0.15	5.66	g/m ² /year
R134a	Test pressure	7.1	60.0	bar
	QUADRA™ DN2 permeability rate	0.06	8.45	g/m ² /year
	QUADRA™ DN4 permeability rate	0.10	9.37	g/m ² /year
	QUADRA™ DN6 permeability rate	0.07	6.69	g/m ² /year

Figures indicated are average of all the highest obtained values converted from Helium to refrigerant leak rate, as specified within EN 1736:2008.

Test report: BO-TI S- 219890 -TUV- 01 - 03- 12 issued by TÜV Italia

The test method and procedures have been verified by TÜV Italia as third party.

As a result of the assessment and inspection of the characteristics and performance of the permeability test machine, of the test procedures utilized, carried out at the premises of Transfer Oil S.p.A. – Italy, TÜV Italia confirms that it meets the requirements of EN 1736:2008

Transfer Oil declare that all GOMAX® QUADRA™ flexible hoses are fully compliant to the normative. Measurement of permeability have been conducted using leak detector mass spectrometer for the measurement of sniffing helium as specified within EN 1736:2008.

Tests results for all GOMAX® QUADRA™ flexible hoses, when calculated according to EN 1736:2008, achieves CLASS 1 both at 32°C and 100 °C. CLASS 1, as indicated on Normative reference table, is the most stringent permeability category today recognized by the standard.

In reality all GOMAX QUADRA flexible hose are, on average, approximately 95% less than the maximum value allowed as specified by CLASS 1 classification within EN1736:2008.

VISUAL INDEX DN2

1/4 Straight Female Fitting



1/4 Straight Female Fitting + Valve Opener



1/4 Female Elbow 90° Fitting



PAGE 17

Elbow Fitting 90°



"T" fitting

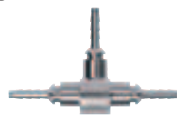

"T" fitting with One Female 1/4 SAE



PAGE 18

"T" Fitting With One Female 1/4 SAE



"T" Fitting With 2 Females 1/4 SAE At 90°



"T" Fitting With 2 Females 1/4 SAE At 180°

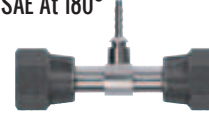

PAGE 19

Cross Fitting

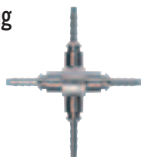

Cross Fitting With 2 Females 1/4 SAE At 180°

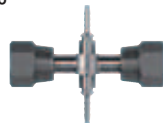

Cross Fitting With 3 Females 1/4 SAE



Cross Fitting With One Female 1/4 SAE



Cross Fitting With 2 Females 1/4 SAE At 90°



1/4 SAE Straight Male



Copper Brazing Fitting (4 X 6 X 100 mm)



PAGE 20

PAGE 21

PAGE 22

1/4 SAE Straight Female Fitting



1/4 SAE Straight Female Fitting + Valve Opener



3/8 SAE Straight Female Fitting



PAGE 33

1/4 SAE Elbow Female 90°



"T" Fitting



T Fitting With One Female 1/4 SAE



Copper Brazing Fitting (4 X 6 X 100 mm)



3/8 SAE Elbow Female 90°



"T" Fitting With One Female 1/4 SAE



1/4 SAE Straight Male Fitting



PAGE 34

PAGE 35

PAGE 36

▲
DN4

1/4 SAE Straight Female Fitting



1/4 SAE Elbow Female 90°



3/8 SAE Elbow Female 90°



3/8 SAE Straight Female Fitting



Copper Brazieng Fitting (6x8) (100 mm)



PAGE 47

PAGE 48

DN6 ▶

APPLICATIONS

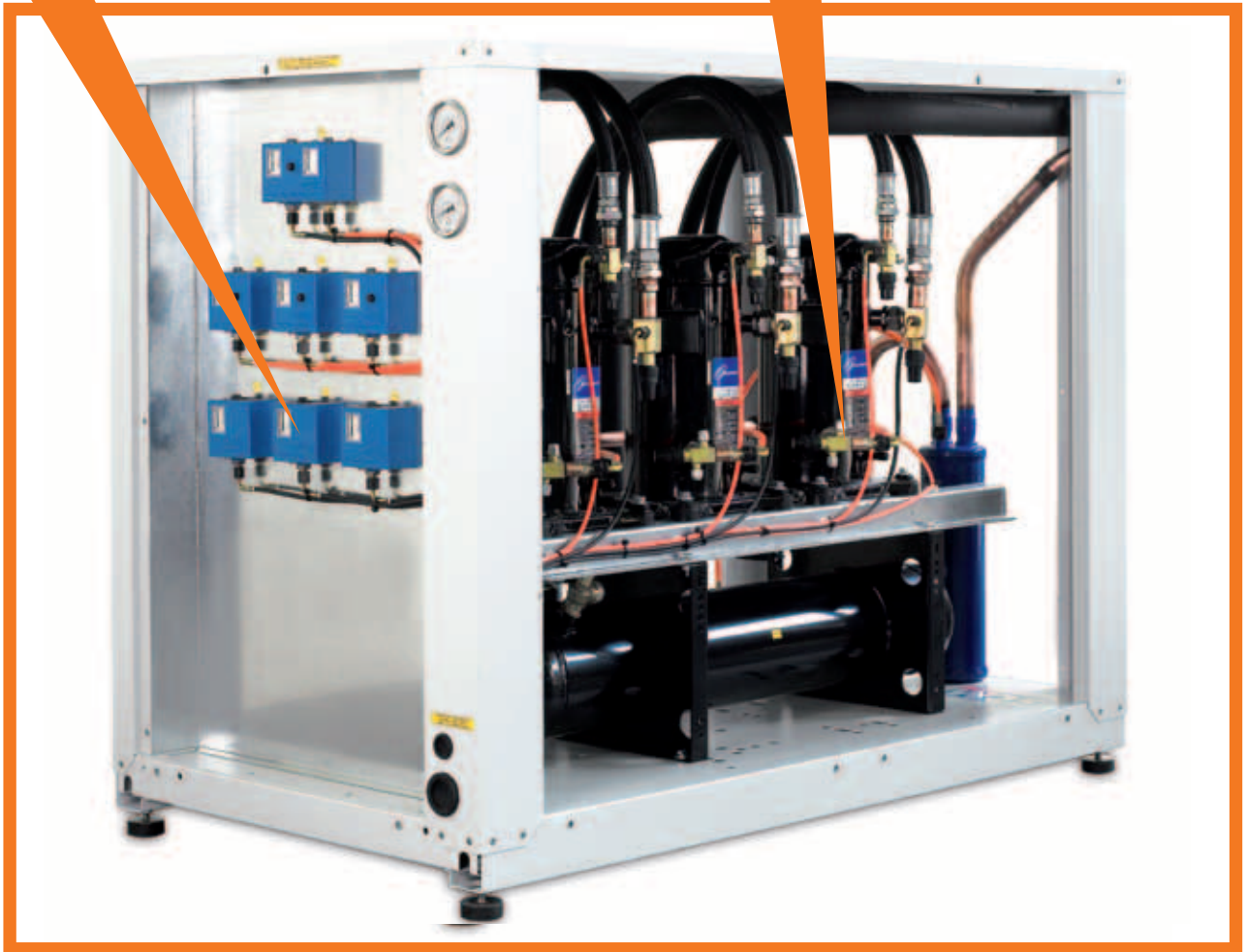
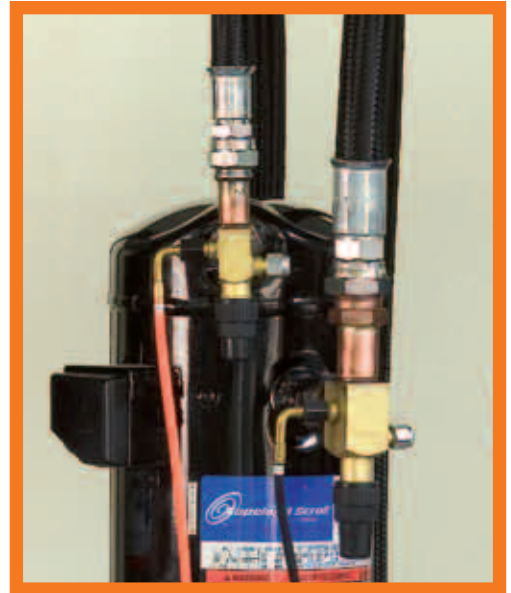

QUADRA:  DN2
QUADRA:  DN4
QUADRA:  DN6
QUADRA:  ACCESSORIES
QUADRA:  PACKAGES

QUADRA DN2

The **QUADRA DN2** flexible thermoplastic capillary hose, in two colors orange and black, represent the most efficient and developed system for the connection of pressure gauges, pressure switches and pressure test points.

Transfer Oil advice the standardization of use of the **QUADRA DN2** hose, choosing the orange color for the high pressure circuits and the black color for the low pressure circuits, so identifying in an unambiguous way the two parts of the circuit.

This reduces the possibilities of misconnections of the two pressure lines of the machine during production and maintenance.

The extraordinary number of **QUADRA DN2** fittings covers all possible types of installations, making the need of copper rigid tubes and capillaries unnecessary.

QUADRA DN2 hoses and fittings can be easily assembled using the specific QUADRA hand pliers RXA007, or the all new QUADRA CRIMP RXA006-RXA008.



QUADRA:  DN2

QUADRA:  DN4

QUADRA:  DN6





QUADRA:  ACCESSORIES



QUADRA:  PACKAGES

TECHNICAL DATA

PERFORMANCE and condition of use

part number	Pack	DN	OD mm	WP			BP			TS		BEND RADIUS mm	CRIMPING DIAMETER Ø mm	CRIMPING DIAMETER Ø mm	CRIMPING DIAMETER Ø mm
				bar	MPa	psi	bar	MPa	psi	min °C	max °C				
0780C 0780BC	 50 m	DN2	6,1	120	12,0	1740	600	60	8700	-45°	+130°	10	7±0,1	NA	7±0,15
0780K 0780BK	 10 m														

Classification of QUADRA capillary hoses according to Directive 97/23/CE

PART NUMBER	CLASSIFICATION
0780C 0780BC 0780K 0780BK	paragraph 3 article 3

PERMITTED FLUIDS

Type of Gas	Type of Oil
HFC (R134a, R404A, R407A, R407B, R407C, R410A, R507)	polyol ester based
HCFC (R22)	mineral oils
CO ₂	polyol ester based

Assembly instructions for crimping fittings for QUADRA DN2 capillary hose

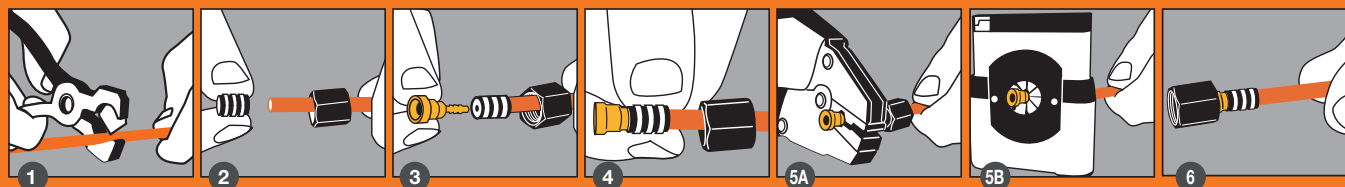

Cut the QUADRA capillary hose to the required length using the special WXA004 cutter.

Slip the nut over the hose (depending on fitting type). Ensure that the threaded side is pointing towards the end of the hose that needs assembling.

When pushing the ferrule over the hose end, ensure its correct positioning, in line with the hose end. Push the insert into the hose end you want to assemble.

Pay attention not to move the components already fitted and slide the ferrule over the hose towards the insert with the insert.

Crimp the ferrule with our hand pliers type RXA007, up to the limit stop of the pliers: once the optimal deformation has been achieved the pliers will open automatically.

Crimp the ferrule with our crimping tool RXA006-RXA008. Keep the lever pulled. Once the optimal deformation has been achieved the crimping tool will stop automatically.

The assembling is finished and the eventual nut can easily slide over the ferrule: check the correct positioning of the components and make sure the entire surface of the ferrule has been swaged.



Note:

ATTENTION: Once the hose assembly connected to the machine, do not move or rotate it, otherwise you risk loosening the nut or damaging the fitting by compromising its tightness. In case you have to modify the orientation of the coupling, unscrew the nut, position the hose assembly, then tighten the nut again respecting the torque value of min 20 N·m, max 25 N·m.

1/4 Straight Female Fitting

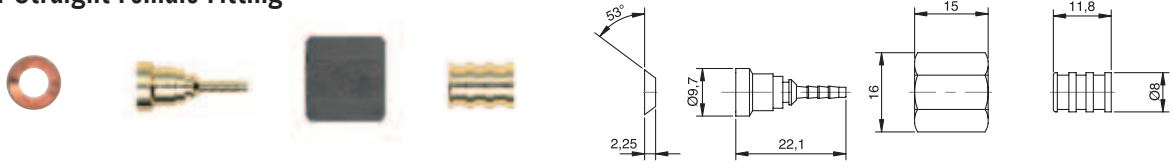

Part number	XBA02C	WBA02C	KBA02C
Pack	50 pcs	50 pcs	10 pcs
Copper gasket			

1/4 Straight Female Fitting + Valve Opener

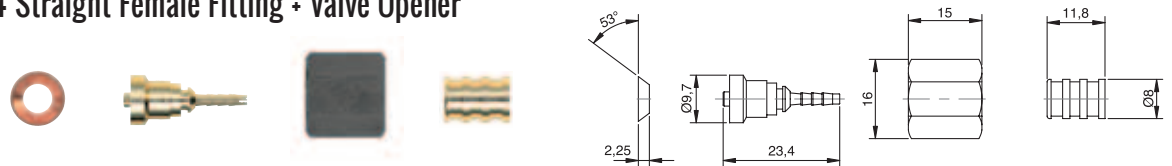

Part number	XBB02C	WBB02C	KBB02C
Pack	50 pcs	50 pcs	10 pcs
Copper gasket			

1/4 Female Elbow 90° Fitting

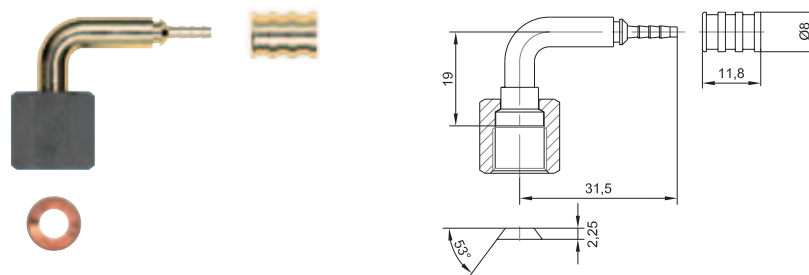

Part number	XCA02C	WCA02C	KCA02C
Pack	50 pcs	50 pcs	10 pcs
Copper gasket			

QUADRA: DN2

QUADRA: DN4

QUADRA: DN6

QUADRA: ACCESSORIES

QUADRA: PACKAGES

QUADRA DN2 fittings

Elbow Fitting 90°

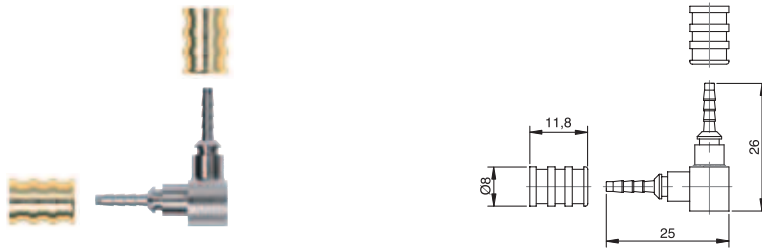

Part number		WPD2C1	KPD2C1
Pack		50 pcs	10 pcs
Copper gasket			

"T" fitting

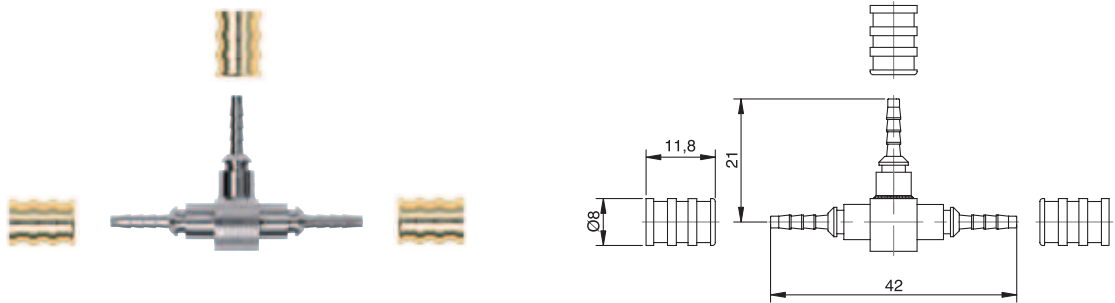

Part number		WPBOC1	KPBOC1
Pack		50 pcs	10 pcs
Copper gasket			

"T" fitting with One Female 1/4 SAE

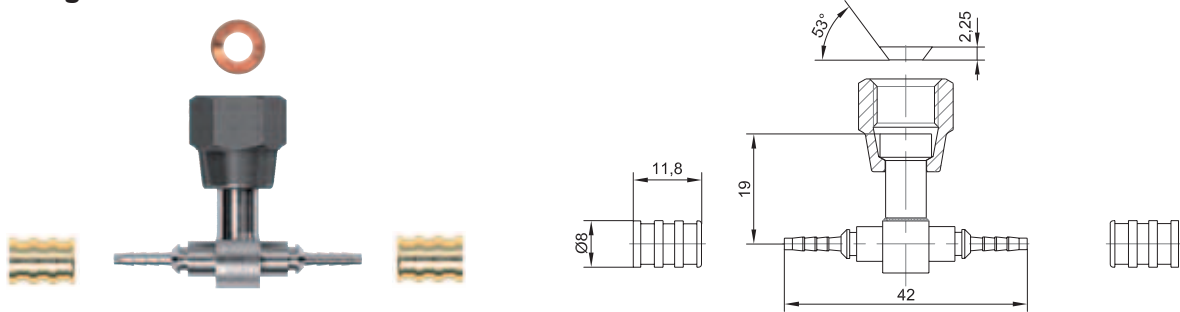





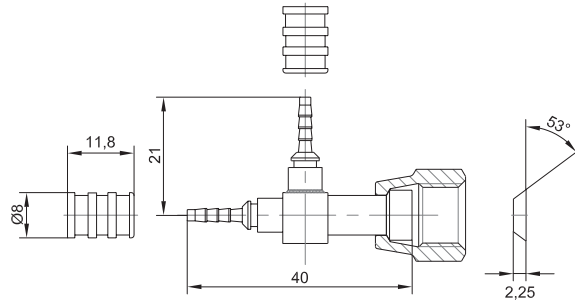
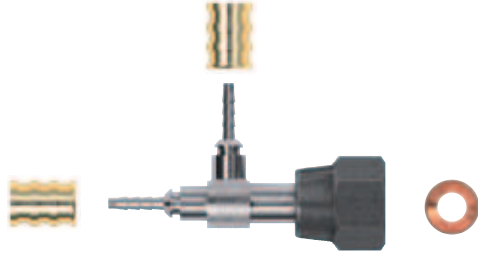

Part number		XPBOC2	WPBOC2	KPBOC2
Pack		50 pcs	50 pcs	10 pcs
Copper gasket				









"T" Fitting With One Female 1/4 SAE

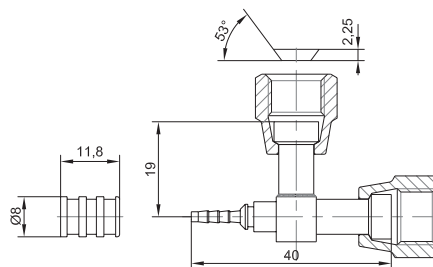
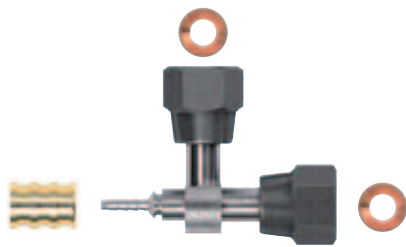

Part number	XPB2C4	WPB2C4	KPB2C4
Pack	 50 pcs	 50 pcs	 10 pcs
Copper gasket			







"T" Fitting With 2 Females 1/4 SAE At 90°

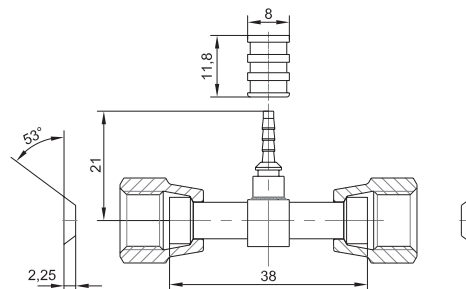
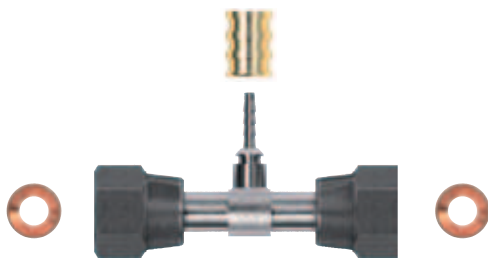

Part number	XPB2C7	WPB2C7	KPB2C7
Pack	 50 pcs	 50 pcs	 10 pcs
Copper gasket			

"T" Fitting With 2 Females 1/4 SAE At 180°



Part number	XPB2C3	WPB2C3	KPB2C3
Pack	 50 pcs	 50 pcs	 10 pcs
Copper gasket			

QUADRA DN2 fittings

Cross Fitting

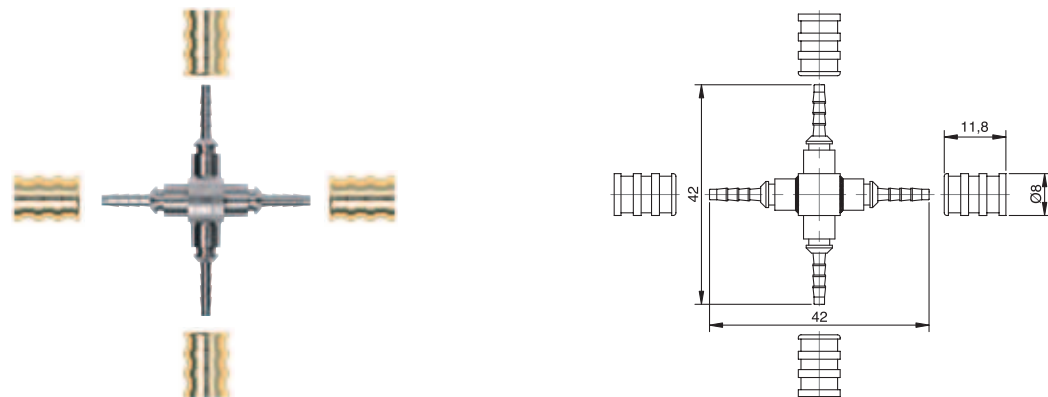

Part number		WPA2C1	KPA2C1
Pack		50 pcs	10 pcs
Copper gasket			

Cross Fitting With One Female 1/4 SAE

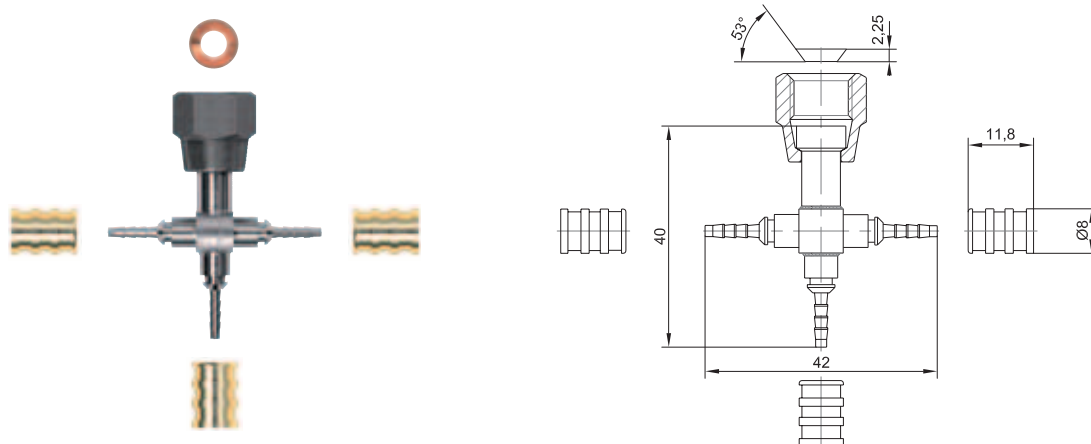

Part number	XPA2C2	WPA2C2	KPA2C2
Pack	50 pcs	50 pcs	10 pcs
Copper gasket			

Cross Fitting With 2 Females 1/4 SAE At 180°

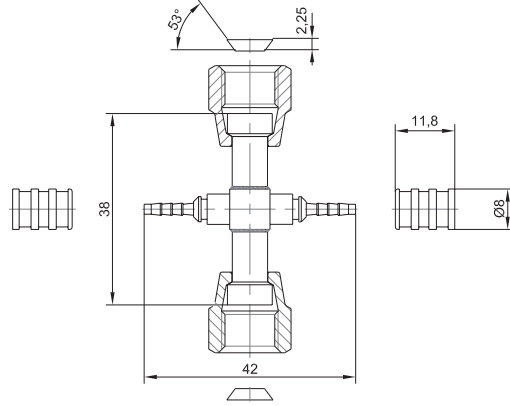
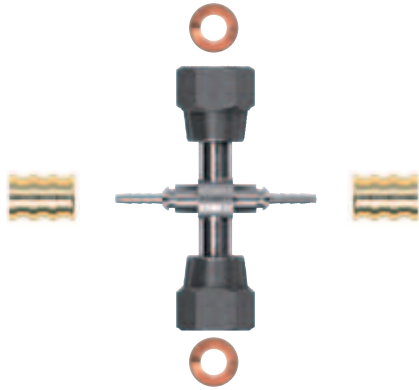

Part number	XPA2C3	WPA2C3	KPA2C3
Pack	50 pcs	50 pcs	10 pcs
Copper gasket			

Cross Fitting With 2 Females 1/4 SAE At 90°

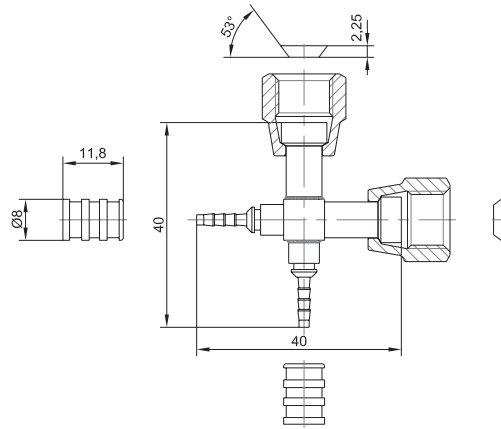
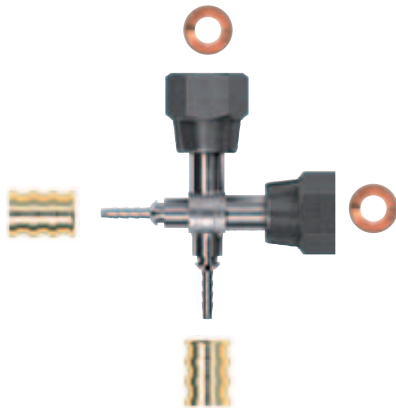

Part number	XPA2C4	WPA2C4	KPA2C4
Pack	50 pcs	50 pcs	10 pcs
Copper gasket			



QUADRA DN2 fittings

Cross Fitting With 3 Females 1/4 SAE

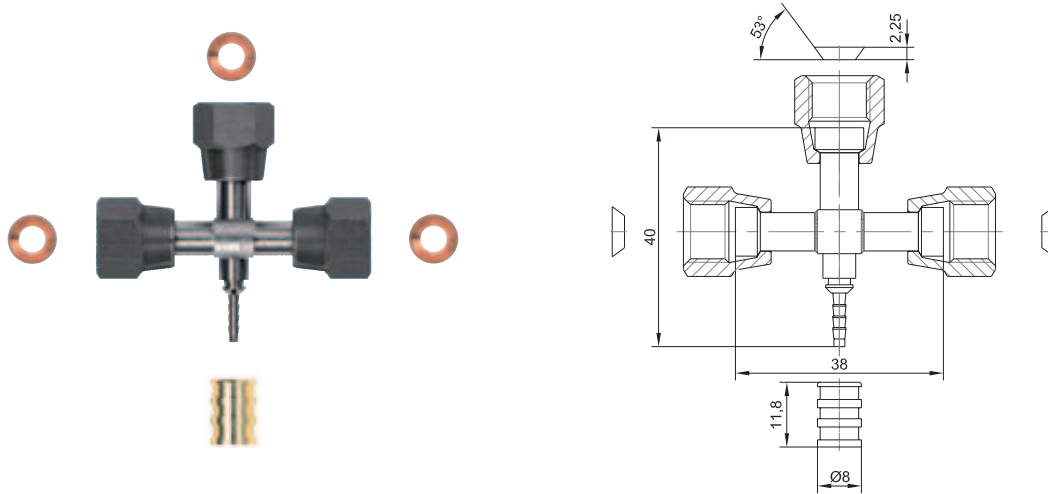

Part number	XPA2C5	WPA2C5	KPA2C5
Pack	50 pcs	50 pcs	10 pcs
Copper gasket			

1/4 SAE Straight Male

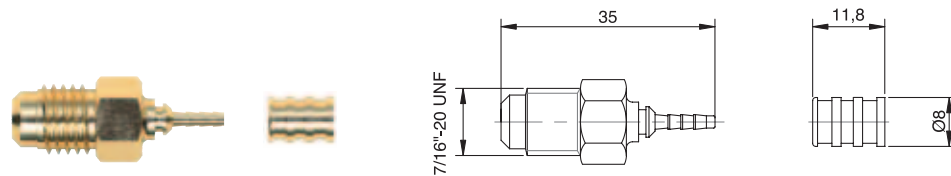

Part number	WDN22C	KDN22C
Pack	50 pcs	10 pcs
Copper gasket		

Copper Brazing Fitting (4 X 6 X 100 mm)

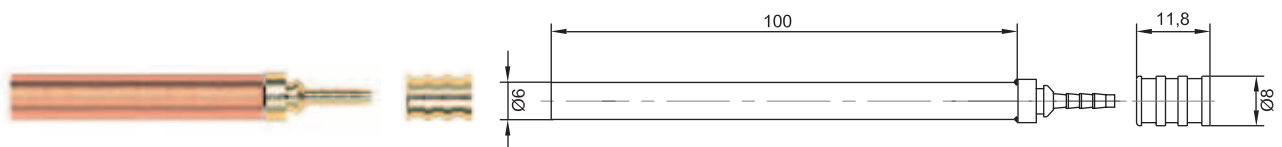

Part number	WZE2C1
Pack	50 pcs

accessories for **QUADRA DN2** hoses

HAND PLIERS



Part number

RXA007

Pack



1 pcs

CUTTER AND BLADES

Cutter



Cutter blades



Part number

WXA004

WXB004

Pack



1 pcs



2 pcs

VALVE OPENER, GASKET AND NUT CAPS

Removable valve opener



Copper gasket 1/4



QUADRA 1/4 fitting plugs

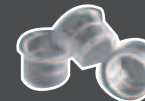

Part number

WTD2Z1

WRP502

WRW912

Pack



50 pcs



50 pcs



50 pcs

QUADRA-CRIMP

details on page 52



Part number

RXA006
RXA008

Pack



1 pcs

QUADRA CASE

Empty



Complete

- 10 m. ref. 0780K
- 10 m. ref. 0780BK
- 20 ref. WBA02C
- 20 ref. WBB02C
- 10 ref. WCA02C
- 10 ref. WPB0C1
- 10 ref. WPB0C2
- 50 ref. WRP502
- 50 ref. WTD2Z1
- 1 ref. RXA007
- 1 ref. RXA004
- 2 ref. WXB004

Part number

MRO43

W00001

Pack



1 pcs



1 pcs

QUADRA: DN2

QUADRA: DN4

QUADRA: DN6



QUADRA: ACCESSORIES



QUADRA: PACKAGES

QUADRA DN2 assembled capillary hoses

1/4 Straight Female + 1/4 Straight Female

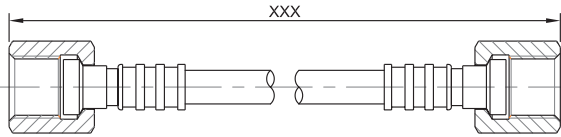

Part number	CAAXXX	CCBXXX
Pack	 50 pcs	 50 pcs

Female 1/4 + Female 1/4 + VALVE OPENER

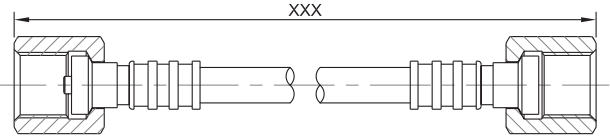

Part number	CCJXXX	CEQXXX
Pack	 50 pcs	 50 pcs

1/4 Straight Female + 1/4 Elbow Female

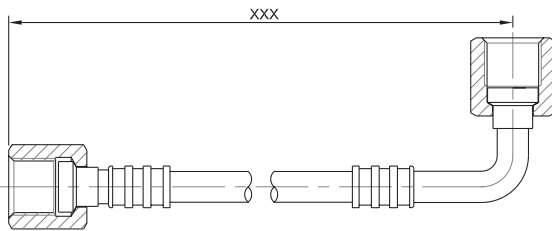

Part number	CACXXX	CCDXXX
Pack	 50 pcs	 50 pcs

Straight Female 1/4 + "T" with 2 Females 1/4 at 180°

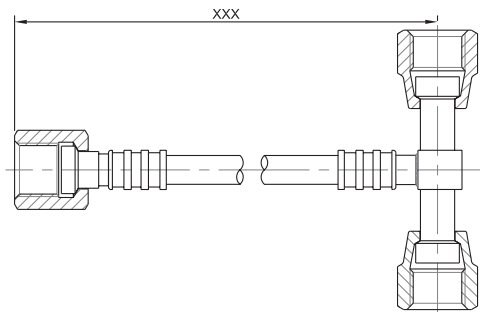

Part number	CETXXX	CEUXXX
Pack	 50 pcs	 50 pcs

Straight Female 1/4 + "T" with 2 Females 1/4 at 90°

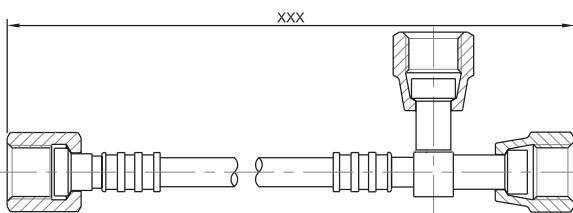

Part number	CEVXXX	CEWXXX
Pack	 50 pcs	 50 pcs

Straight Female 1/4 + Cross with 3 Females 1/4

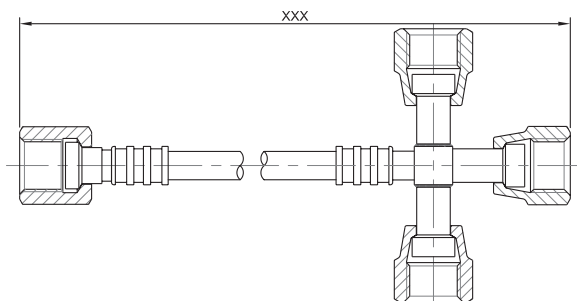

Part number	CExxxx	CEYXXX
Pack	 50 pcs	 50 pcs

QUADRA DN2 assembled capillary hoses

Straight Female 1/4 + Male 1/4

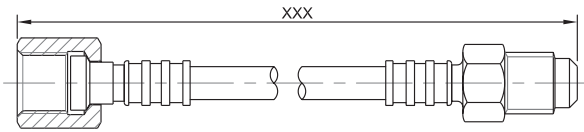

Part number	CERXXX	CESXXX
Pack	 50 pcs	 50 pcs

Straight Female 1/4 + Copper brazing tube

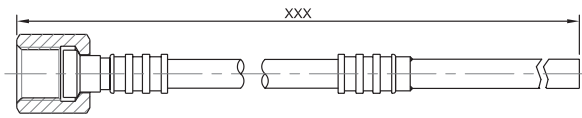

Part number	CEZXXX	CFAXXX
Pack	 50 pcs	 50 pcs

1/4 Straight Female + 1/4 Straight Female (All With Valve Opener)

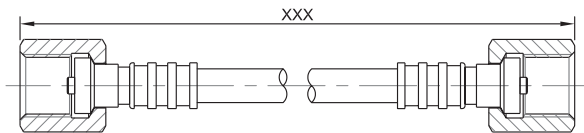

Part number	CABXXX	CCCXXX
Pack	 50 pcs	 50 pcs

1/4 Straight Female (With Valve Opener) + 1/4 T With 2 Females At 180°

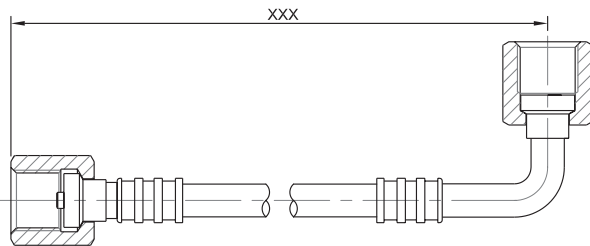

Part number	CADXXX	CCEXXX
Pack	 50 pcs	 50 pcs

1/4 Straight Female (With Valve Opener) + T With 2 Female 1/4 at 180°

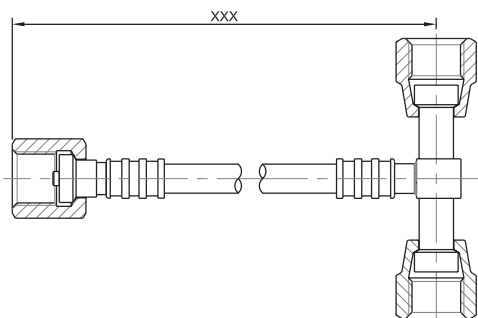

Part number	CFDXXX	CFEXXX
Pack	 50 pcs	 50 pcs

Straight Female 1/4 With Valve Opener + T With 2 Females 1/4 At 90°

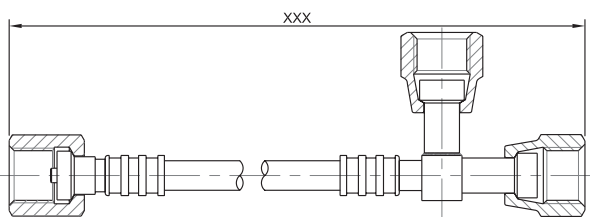

Part number	CFFXXX	CFGXXX
Pack	 50 pcs	 50 pcs

 - QUADRA orange

 - QUADRA black

XXX - total length of QUADRA capillary hose in cm (multiple lengths of 10 cm)



QUADRA DN2 assembled capillary hoses

Straight Female 1/4 With Valve Opener + Cross With 3 Females 1/4

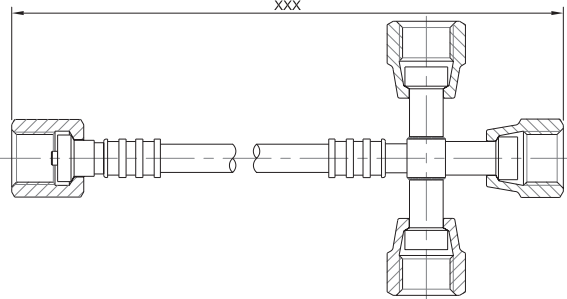

Part number

CFHXXX

CFIXXX

Pack



Straight Female 1/4 With Valve Opener + Male 1/4

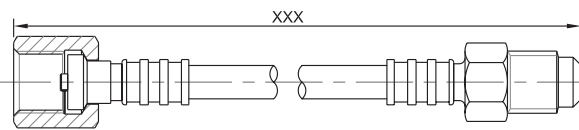

Part number

CFBXXX

CFCXXX

Pack



Straight Female 1/4 With Valve Opener + Copper Brazing Tube

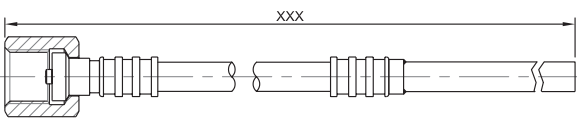

Part number

CFJXXX

CFKXXX

Pack



1/4 Elbow Female + 1/4 Elbow Female

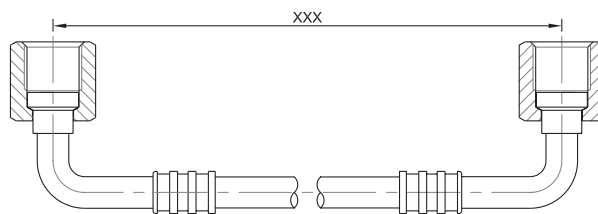

Part number

CAEXXX

CCFXXX

Pack



Elbow Female 90° 1/4 + T With 2 Females 1/4 At 180°

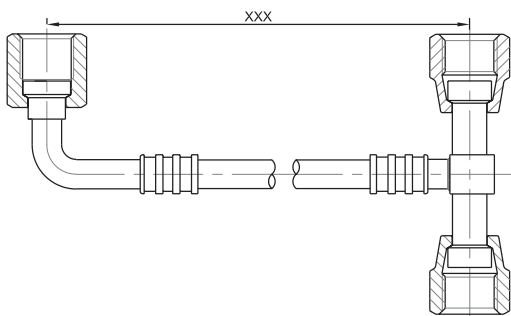

Part number

CFPXXX

CFQXXX

Pack



Elbow Female 90° 1/4 + T With 2 Females 1/4 At 90°

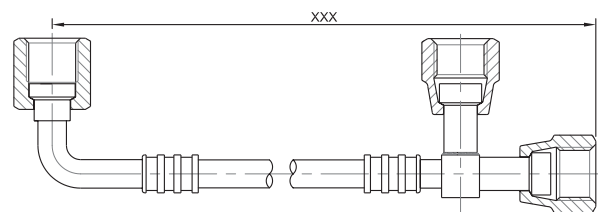

Part number

CFRXXX

CFSXXX

Pack



QUADRA DN2 assembled capillary hoses

Elbow Female 90° 1/4 + Cross with 3 Females 1/4

Part number	CFTXXX	CFUXXX
Pack	50 pcs	50 pcs

Elbow Female 90° 1/4 + Male 1/4

Part number	CFNXXX	CFOXXX
Pack	50 pcs	50 pcs

Elbow Female 90° 1/4 + Copper brazing tube

Part number	CFVXXX	CFWXXX
Pack	50 pcs	50 pcs

"T" with 2 Females 1/4 at 180° + "T" with 2 Females 1/4 at 180°

Part number	CGHXXX	CGIXXX
Pack	50 pcs	50 pcs

"T" with 2 Females 1/4 at 180° + "T" with 2 Females 1/4 at 90°

Part number	CGJXXX	CGKXXX
Pack	50 pcs	50 pcs

"T" with 2 Females 1/4 at 180° + Cross with 3 Females 1/4

Part number	CGLXXX	CGMXXX
Pack	50 pcs	50 pcs

QUADRA: DN2

QUADRA: DN4

QUADRA: DN6



QUADRA: ACCESSORIES



QUADRA: PACKAGES

QUADRA DN2 assembled hoses

Male 1/4 + "T" With 2 Females 1/4 At 180°

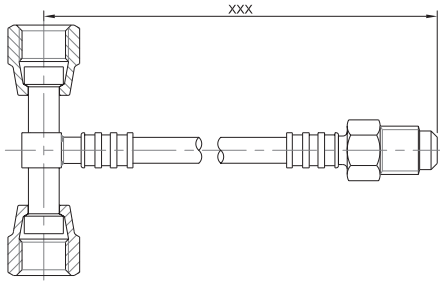

Part number

CFZXXX

CGAXXX

Pack



"T" With 2 Females 1/4 At 180° + Copper Brazing Tube

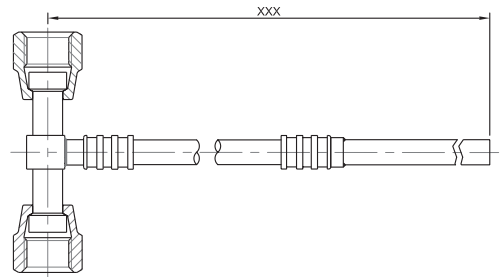

Part number

CGNXXX

CGOXXX

Pack



"T" With 2 Females 1/4 At 90° + "T" With 2 Females 1/4 At 90°

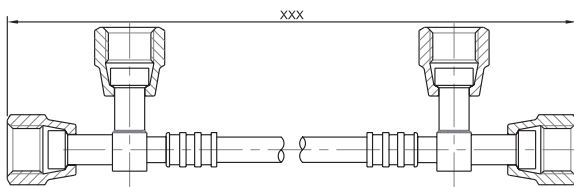

Part number

CGPXXX

CGQXXX

Pack



"T" With 2 Females 1/4 At 90° + Cross With 3 Females 1/4

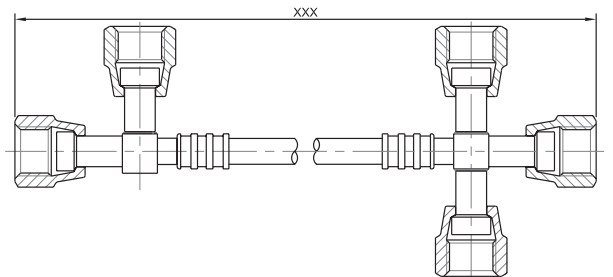

Part number

CGRXXX

CGSXXX

Pack



Male 1/4 + "T" With 2 Females 1/4 At 90°

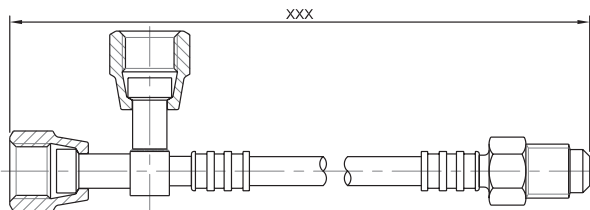

Part number

CGBXXX

CGCXXX

Pack



"T" With 2 Females 1/4 At 90° + Copper Brazing Tube

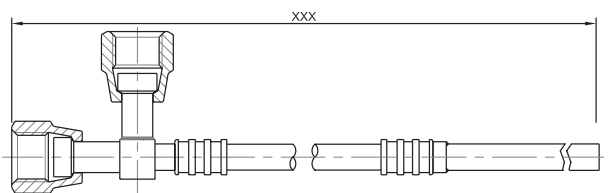

Part number

CGTXXX

CGUXXX

Pack



QUADRA DN2 assembled hoses

Cross with 3 Females 1/4 + Cross with 3 Females 1/4

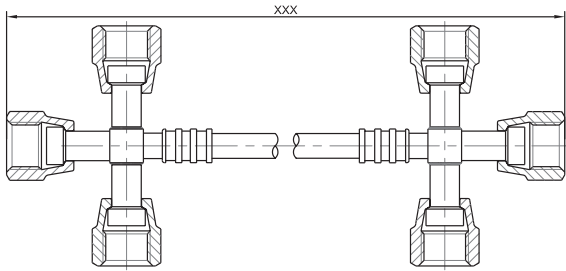

Part number **CGVXXX** **CGWXXX**

Pack 50 pcs 50 pcs

Male 1/4 + Cross with 3 Females 1/4

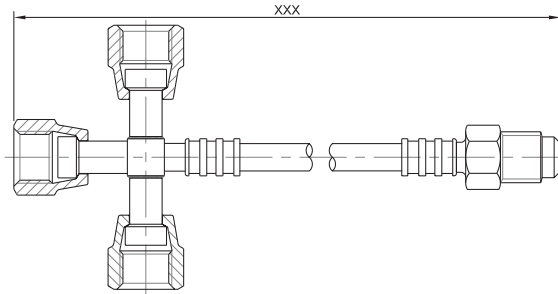

Part number **CGDXXX** **CGEXXX**

Pack 50 pcs 50 pcs

Cross with 3 Females 1/4 + Copper brazing tube

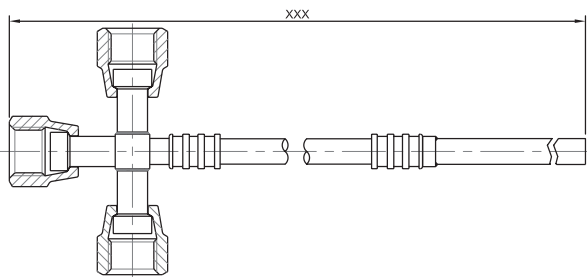

Part number **CGXXXX** **CGYXXX**

Pack 50 pcs 50 pcs

Male 1/4 + Male 1/4

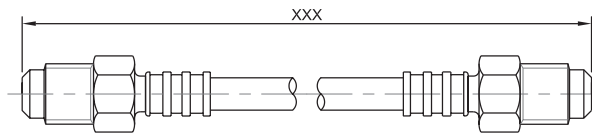

Part number **CFXXXX** **CFYXXX**

Pack 50 pcs 50 pcs

Male 1/4 + Copper brazing tube

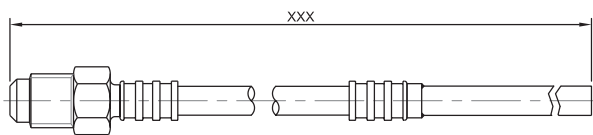

Part number **CGFXXX** **CGGXXX**

Pack 50 pcs 50 pcs

Copper brazing tube + Copper brazing tube

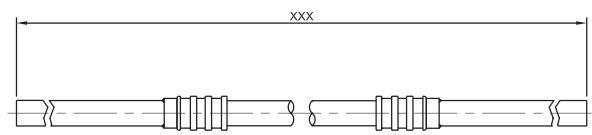

Part number **CHZXXX** **CHAXXX**

Pack 50 pcs 50 pcs

- QUADRA orange - QUADRA black
 XXX - total length of QUADRA capillary hose in cm (multiple lengths of 10 cm)



APPLICATIONS

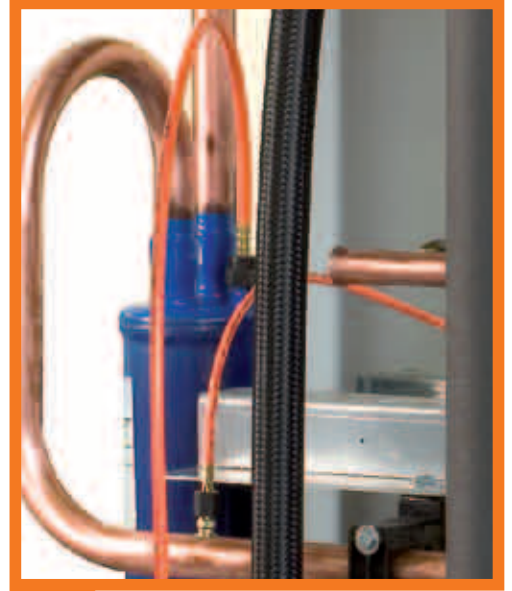

QUADRA:  DN2
QUADRA:  DN4
QUADRA:  DN6
QUADRA:  ACCESSORIES
QUADRA:  PACKAGES

QUADRA DN4

The **QUADRA DN4** flexible thermoplastic capillary hose, in two colors orange and black, are the ideal solution for equalizing and oil return lines.

The **QUADRA DN4** hoses have an internal diameter of 4 mm and therefore they can substitute copper rigid tubing of OD 6 mm or 1/4".

The **QUADRA DN4** hoses can be easily assembled with suitable fittings and crimped using the specific hydraulic crimper RXA005, or the all new QUADRA CRIMP RXA006-RXA008, otherwise a possible alternative is to use special reusable fittings where there are installations where special crimping tools are not available.

The **QUADRA DN4** hose can also be used, at the choice of the user, also for connection to the pressure gauges, pressure switches and test points as with QUADRA DN2.



QUADRA: DN2

QUADRA: DN4

QUADRA: DN6

QUADRA: ACCESSORIES

QUADRA: PACKAGES

TECHNICAL DATA

PERFORMANCE and condition of use

part number	Pack	DN	OD mm	WP			BP			WT		BEND RADIUS mm	CRIMPING DIAMETER Ø mm	CRIMPING DIAMETER Ø mm	CRIMPING DIAMETER Ø mm
				bar	MPa	psi	bar	MPa	psi	min°C	max°C				
0789C 0789BC	50 m	DN4	8,30	120	12,0	1740	600	60	8700	-45°	+130°	25	NA	9,6 ±0,1	10 ±0,15
0789K 0789BK	10 m														

Classification of QUADRA capillary hoses according to Directive 97/23/CE

PART NUMBER	CLASSIFICATION
0789C 0789BC 0789K 0789BK	paragraph 3 article 3

PERMITTED FLUIDS

Type of Gas	Type of Oil
HFC (R134a, R404A, R407A, R407B, R407C, R410A, R507)	polyol ester based
HCFC (R22)	mineral oils
CO ₂	polyol ester based

Assembly instructions for crimping fittings for QUADRA DN4 capillary hose

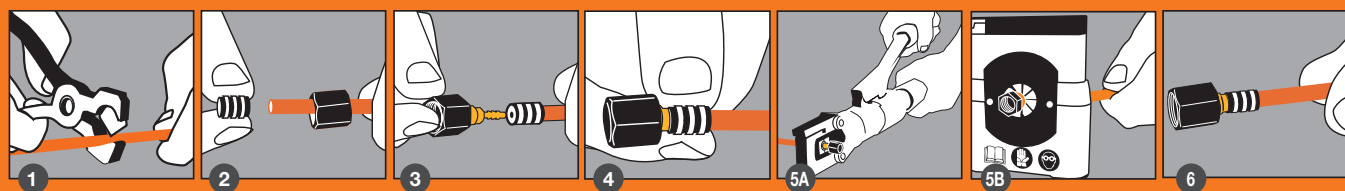

Cut the QUADRA capillary hose to the required length using the special WXA004 cutter.

Slip the nut over the hose (depending on fitting type). Ensure that the threaded side is pointing towards the end of the hose that needs assembling.

Assemble the insert together with the nut onto the hose end.

Pay attention not to move the components already fitted and slide the ferrule over the hose towards the insert positioning it in line with the insert.

Crimp the ferrule with our hand pliers type RXA005, up to the limit stop of the pliers: once the optimal deformation has been achieved the pliers will open automatically.

Crimp the ferrule with our crimping machine RXA006-RXA008. Keep the lever pulled. Once the optimal deformation has been achieved the crimping machine will stop automatically.

The assembling is finished and the eventual nut can easily slide over the ferrule: check the correct positioning of the components and make sure the entire surface of the ferrule has been swaged.



Note:

ATTENTION: Once the hose assembly connected to the machine, do not move or rotate it, otherwise you risk loosening the nut or damaging the fitting by compromising its tightness. In case you have to modify the orientation of the coupling, unscrew the nut, position the hose assembly, then tighten the nut again respecting the torque value of max min 20 N·m.

1/4 SAE Straight Female Fitting

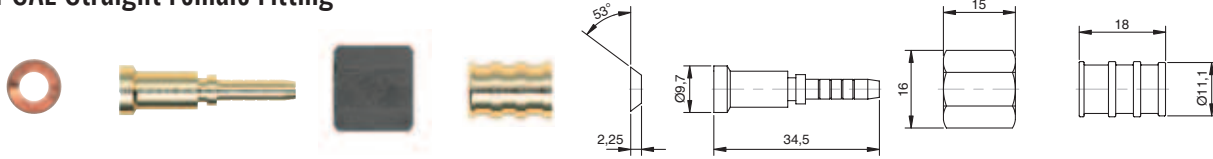

Part number	XBA02M	WBA02M	KBA02M
Pack	50 pcs	50 pcs	10 pcs
Copper gasket			

1/4 SAE Straight Female Fitting + Valve Opener

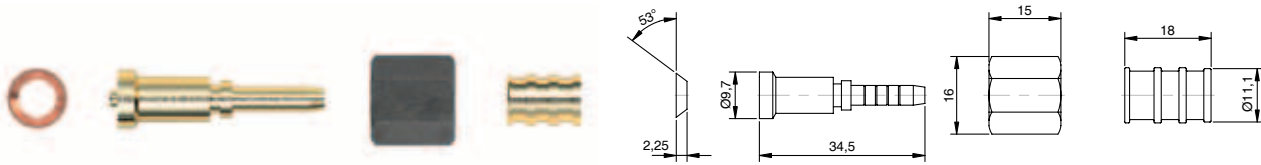

Part number	XBB22M	WBB22M	KBB22M
Pack	50 pcs	50 pcs	10 pcs
Copper gasket			

3/8 SAE Straight Female Fitting

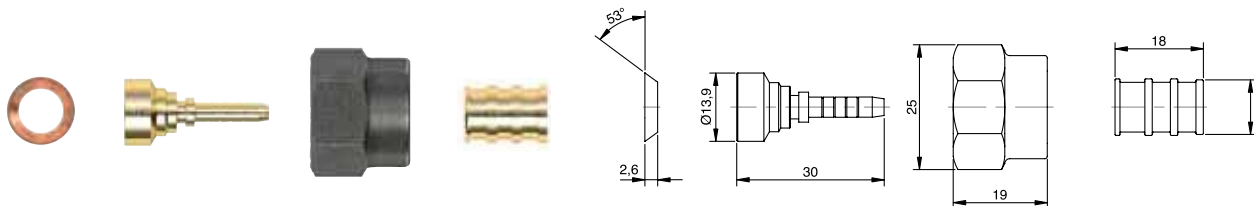

Part number	XBA04M	WBA04M	KBA04M
Pack	50 pcs	50 pcs	10 pcs
Copper gasket			

QUADRA DN4 fittings

1/4 SAE Elbow Female 90°

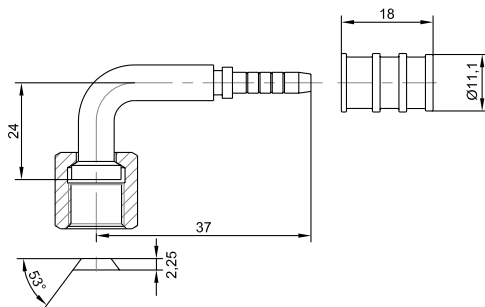

Part number	XCA02M	WCA02M	KCA02M
Pack	50 pcs	50 pcs	10 pcs
Copper gasket			

3/8 SAE Elbow Female 90°

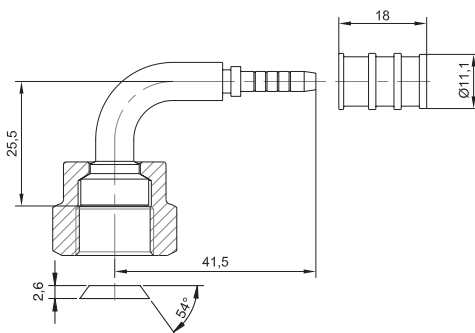
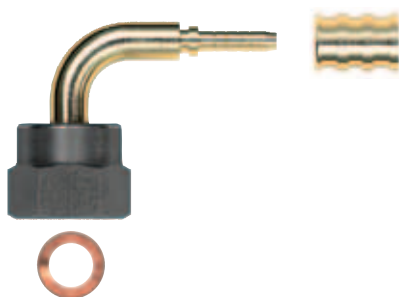

Part number	XCA04M	WCA04M	KCA04M
Pack	50 pcs	50 pcs	10 pcs
Copper gasket			

"T" Fitting

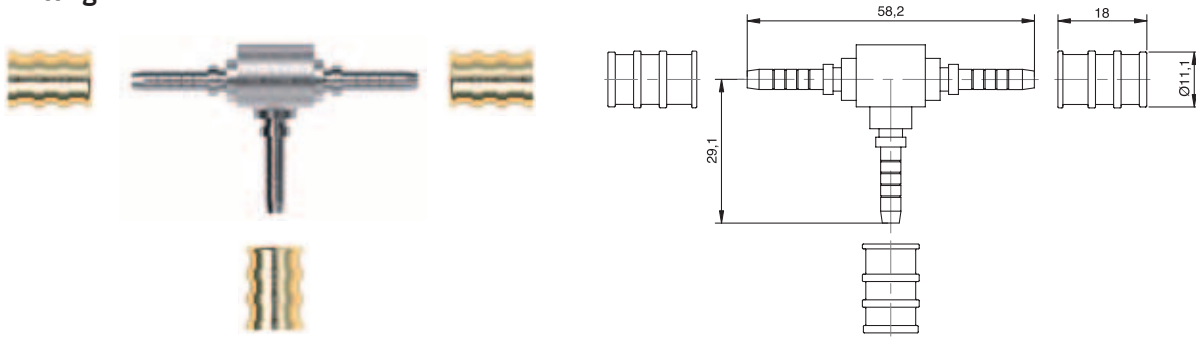

Part number		WPBOM1	KPBOM1
Pack		50 pcs	10 pcs
Copper gasket		○	○

"T" Fitting With One Female 1/4 SAE

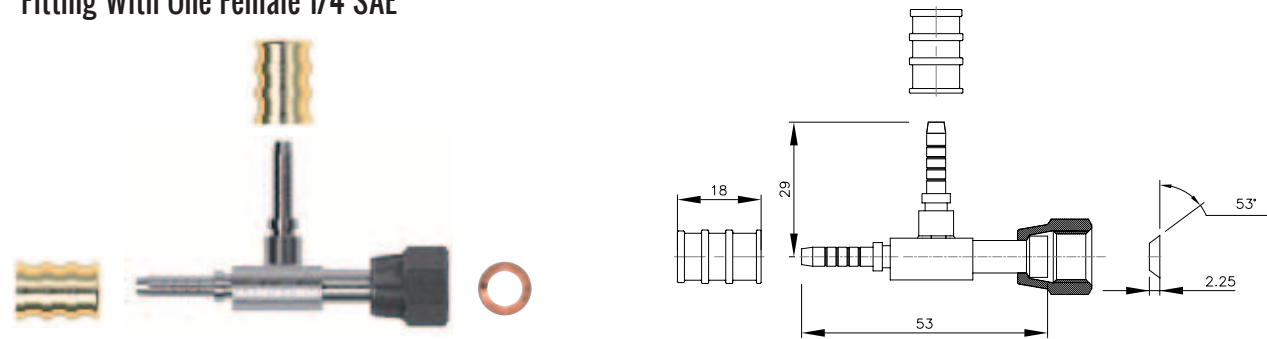

Part number	XPB2M4	WPB2M4	KPB2M4
Pack	50 pcs	50 pcs	10 pcs
Copper gasket	○	○	○



QUADRA DN4 fittings

"T" Fitting With One Female 1/4 SAE

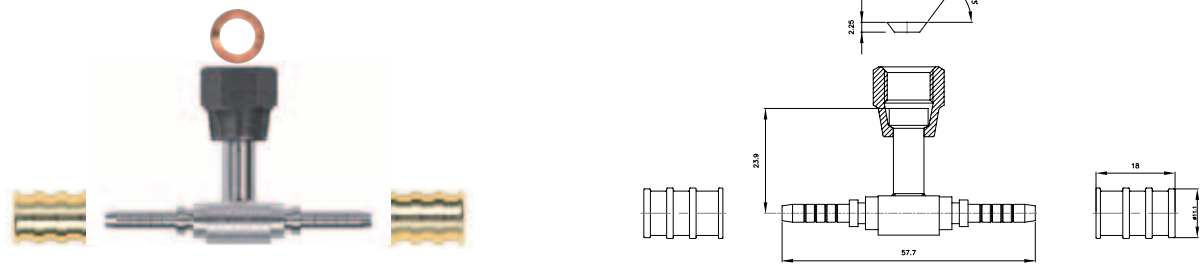

Part number	XPB2M2	WPB2M2	KPB2M2
Pack	50 pcs	50 pcs	10 pcs
Copper gasket			

1/4 SAE Straight Male Fitting

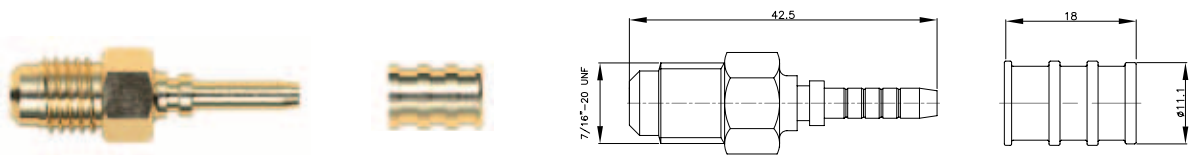

Part number	WDN22M	KDN22M
Pack	50 pcs	10 pcs
Copper gasket		

Copper Brazing Fitting (4 X 6 X 100 mm)

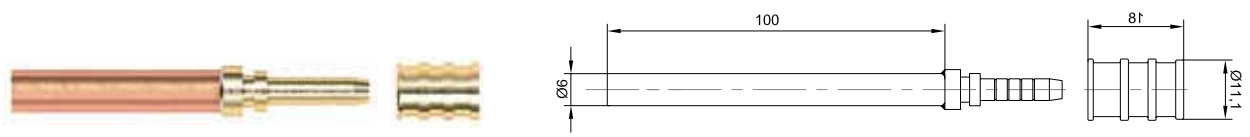

Part number	WZE2M1	
Pack	50 pcs	
Copper gasket		

QUADRA REUSABLE FITTINGS

Assembly instructions for reusable fittings for QUADRA DN4 capillary hose

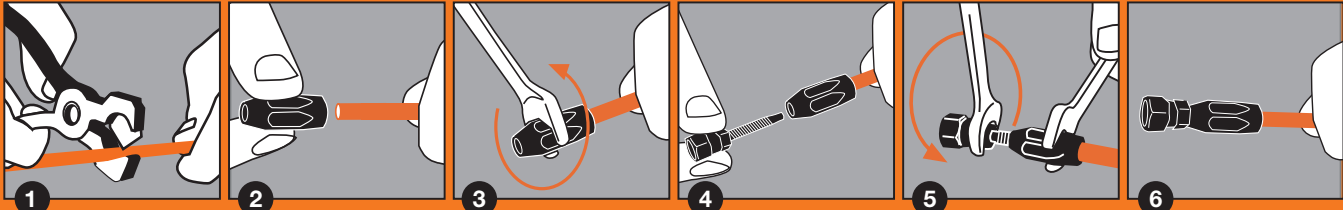

1 Cut QUADRA DN4 capillary hose to the required length using our cutter for capillary hoses type WXA004.

2 Push the ferrule over the hose end you want to assemble. To make the operation easier we advise that you lubricate the components with refrigeration oil.

3 Screw counter clockwise, by hand, the first turns of the thread of the ferrule. A suitable wrench screw counter clockwise until the ferrule is in line with the hose.

4 Place the insert into the hose end you want to assemble. To make the operation easier we advise that you lubricate the components with refrigeration oil.

5 Screw clockwise, by hand, the first turns of the thread of the insert into the ferrule previously fitted on the hose. Screw clockwise the fitting into the ferrule until they are in line with each other by using a wrench and a counter wrench.

6 After checking the correct positioning of the components, the assembling is finished.

1/4 SAE Straight Female Fitting

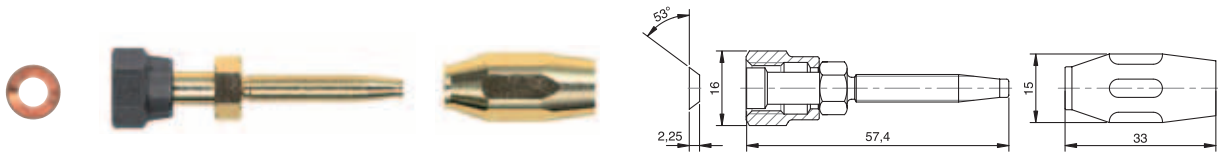

Part number	XIA02M	WIA02M	KIA02M
Pack	50 pcs	50 pcs	10 pcs
Copper gasket			

1/4 SAE Elbow Female 90° Fitting

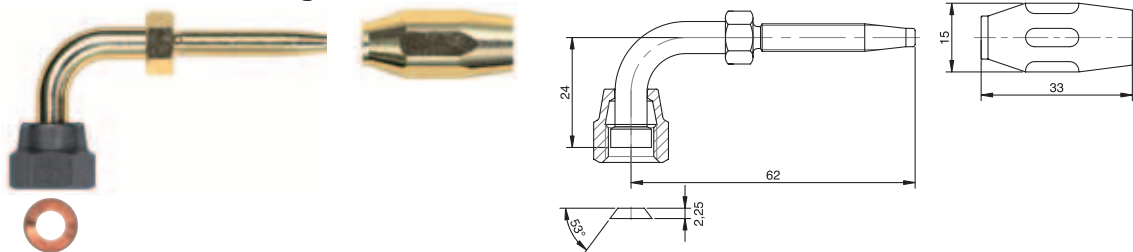

Part number	XJAO2M	WJAO2M	KJAO2M
Pack	50 pcs	50 pcs	10 pcs
Copper gasket			

QUADRA: DN2

QUADRA: DN4

QUADRA: DN6



QUADRA: ACCESSORIES



QUADRA: PACKAGES

accessories for **QUADRA DN4** hoses

HYDRAULIC PLIERS



Part number	RXA005
Pack	1 pcs

CUTTER AND BLADES

Cutter



Cutter blades



Part number	WXA004	WXB004
Pack	1 pcs	2 pcs

VALVE OPENER, GASKET AND NUT CAPS

Removable valve opener



Copper gasket 1/4



Copper gasket 3/8



QUADRA 1/4 fitting plugs

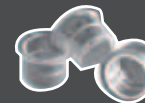

QUADRA 3/8 fitting plugs

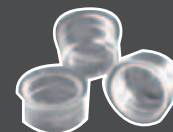

Part number	WTD2Z1	WRP502	WRP504	WRW912	WRW914
Pack	50 pcs	50 pcs	50 pcs	50 pcs	50 pcs

QUADRA-CRIMP

details on page 52



Part number	RXA006 RXA008
Pack	1 pcs

QUADRA CASE

Empty



Part number	MR043
Pack	1 pcs

QUADRA DN4 assembled capillary hoses

Straight female 1/4 + Straight female 1/4

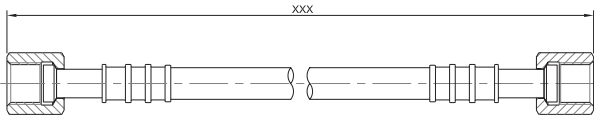

Part number	CAFXXX	CCGXXX
Pack	50 pcs	50 pcs

Straight Female 1/4 + Straight Female 1/4 + Valve Opener

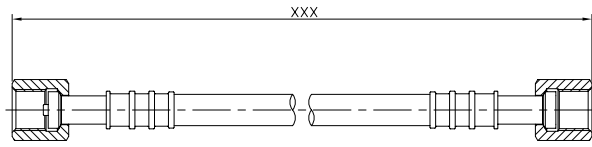

Part number	CHVXXX	CHWXXX
Pack	50 pcs	50 pcs

Straight female 1/4 + Straight female 3/8

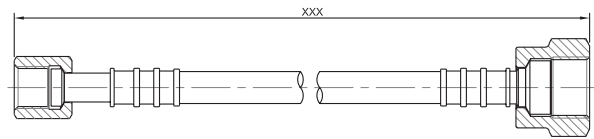

Part number	CCMXXX	CCNXXX
Pack	50 pcs	50 pcs

Straight female 1/4 + Elbow female 90° 1/4

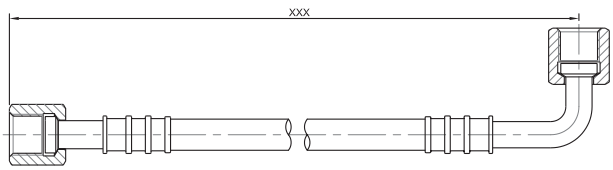

Part number	CAGXXX	CCHXXX
Pack	50 pcs	50 pcs

Straight female 1/4 + Elbow female 90° 3/8

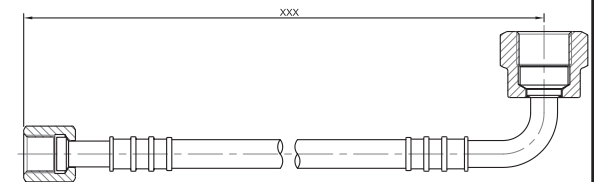

Part number	CDSXXX	CDWXXX
Pack	50 pcs	50 pcs

Straight Female 1/4 with valve opener + Male 1/4

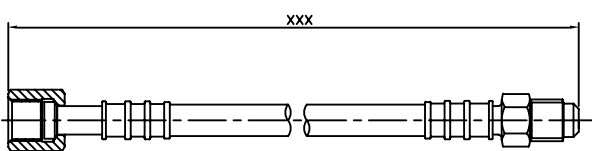

Part number	CIRXXX	CISXXX
Pack	50 pcs	50 pcs

■ - QUADRA orange ■ - QUADRA black
xxx - total length of QUADRA capillary hose in cm (multiple lengths of 10 cm)



QUADRA DN4 assembled capillary hoses

Straight female 1/4 + Copper brazing tube

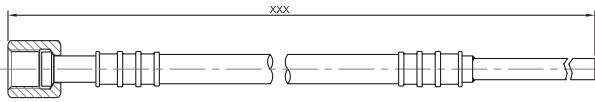

Part number	CHBXXX	CHCXXX
Pack	50 pcs	50 pcs

1/4 Straight Female + 1/4 Straight Female (all with valve opener)

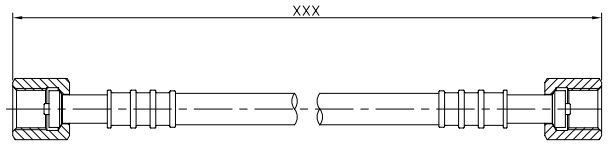

Part number	CHZXXX	CIAXXX
Pack	50 pcs	50 pcs

1/4 Straight Female (Valve Opener) + 3/8 Straight Female

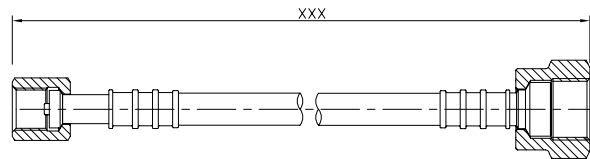

Part number	CIFXXX	CIDXXX
Pack	50 pcs	50 pcs

1/4 Straight Female (Valve Opener) + 1/4 Elbow Female

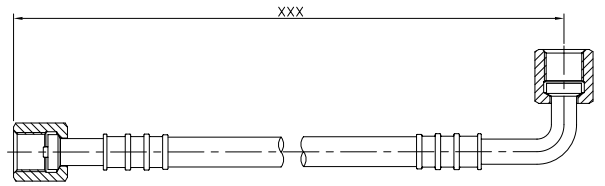

Part number	CIBXXX	CICXXX
Pack	50 pcs	50 pcs

1/4 Straight Female (Valve Opener) + 3/8 Elbow Female

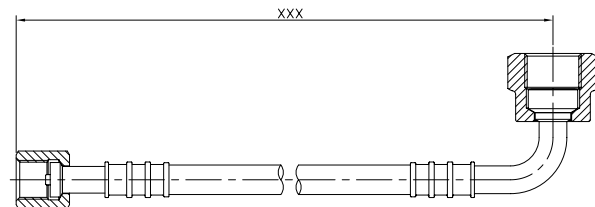

Part number	CIDXXX	CIEXXX
Pack	50 pcs	50 pcs

1/4 Straight Female (Valve Opener) + 1/4 Male

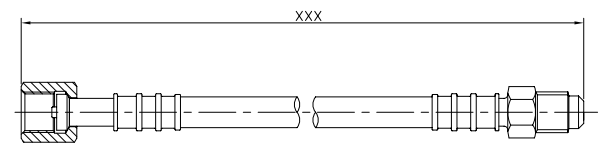

Part number	CHXXX	CHYXXX
Pack	50 pcs	50 pcs

QUADRA DN4 assembled capillary hoses

1/4 Straight Female (Valve Opener) + Copper Brazing Tube

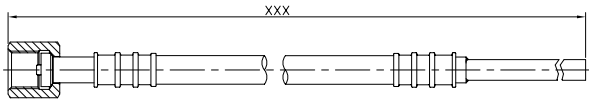

Part number	CIHXXX	CIIXXX
Pack	 50 pcs	 50 pcs

Straight Female 3/8 + Straight female 3/8

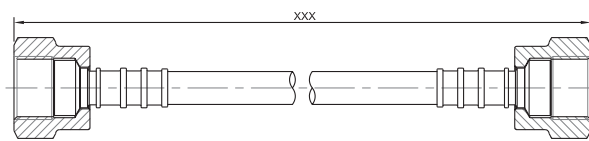

Part number	CCKXXX	CCLXXX
Pack	 50 pcs	 50 pcs

Elbow Female 90° 1/4 + Straight Female 3/8

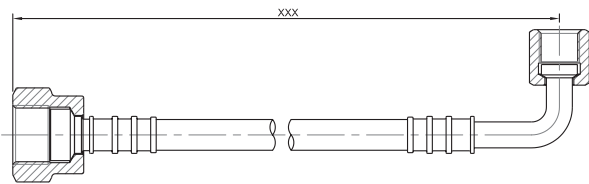

Part number	CCPXXX	CCQXXX
Pack	 50 pcs	 50 pcs

Elbow female 90° 1/4 + Elbow female 90° 1/4

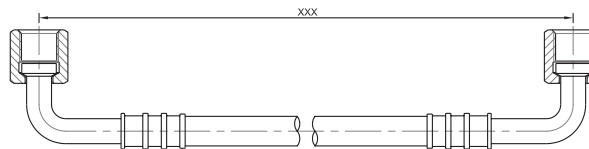

Part number	CAHXXX	CGIXXX
Pack	 50 pcs	 50 pcs

Elbow Female 90° 1/4 + Straight Female 90° 3/8

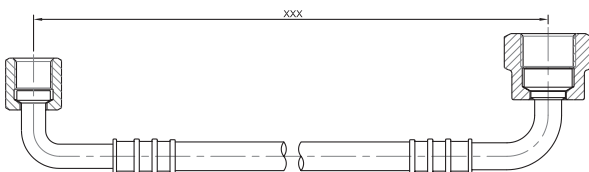

Part number	CDTXXX	CDXXXX
Pack	 50 pcs	 50 pcs

Elbow Female 90° 1/4 + Straight Female 90° 3/8

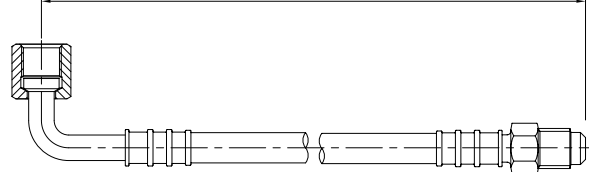

Part number	CIJXXX	CIKXXX
Pack	 50 pcs	 50 pcs

 - QUADRA orange  - QUADRA black
 XXX - total length of QUADRA capillary hose in cm (multiple lengths of 10 cm)



QUADRA DN4 assembled capillary hoses

Elbow Female 90° 1/4 + Copper brazing tube

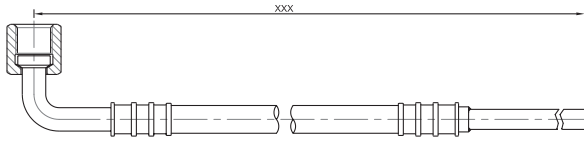

Part number	CHFXXX	CHGXXX
Pack	 50 pcs	 50 pcs

Straight Female 3/8 + Elbow Female 90° 3/8

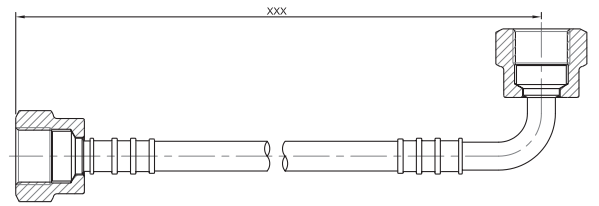

Part number	CDRXXX	CDVXXX
Pack	 50 pcs	 50 pcs

Straight Female 3/8 + Copper brazing tube

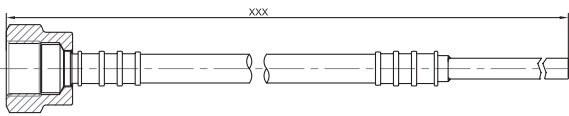

Part number	CHDXXX	CHEXXX
Pack	 50 pcs	 50 pcs

Elbow Female 90° 3/8 + Elbow Female 90° 3/8

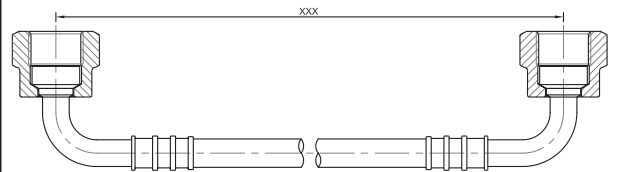

Part number	CDUXXX	CDYXXX
Pack	 50 pcs	 50 pcs

3/8 Elbow Female + 1/4 Male

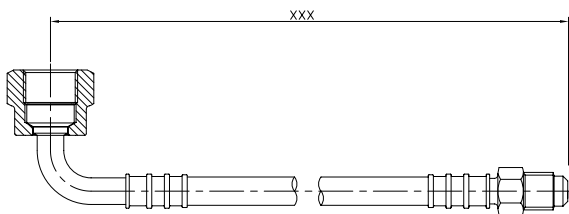

Part number	CILXXX	CIMXXX
Pack	 50 pcs	 50 pcs

Elbow Female 90° 3/8 + Copper Brazing Tube

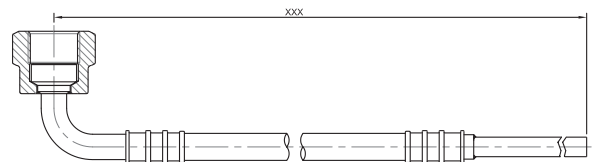

Part number	CHHXXX	CHIXXX
Pack	 50 pcs	 50 pcs

QUADRA DN4 assembled capillary hoses

1/4 Male + 1/4 Male

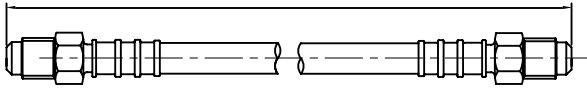

Part number	CINXXX	CIOXXX
Pack	 50 pcs	 50 pcs

1/4 Male + Copper brazing tube

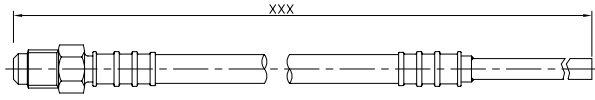

Part number	CIPXXX	CIQXXX
Pack	 50 pcs	 50 pcs

Copper Brazing Tube + Copper Brazing Tube

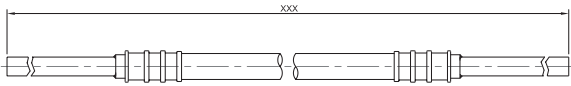

Part number	CHJXXX	CHKXXX
Pack	 50 pcs	 50 pcs

QUADRA:  DN2

QUADRA:  DN4

QUADRA:  DN6



QUADRA:  ACCESSORIES



QUADRA:  PACKAGES

QUADRA DN6

The **QUADRA DN6** flexible thermoplastic hose is the latest QUADRA development in the world of flexible hoses for air conditioning and refrigeration systems.

The **QUADRA DN6** is characterized by an internal diameter of 6 mm, and therefore they can substitute copper rigid tubing of OD 8 mm or 5/16”.

The larger internal diameter reduces the pressure drop and makes the use of this hose possible on larger systems for the oil return lines and for the oil equalization systems.

The crimping fittings for the **QUADRA DN6** hose are available with connections of 1/4” SAE and 3/8” SAE and can be connected to the hose using the same hydraulic pliers RXA005 as used with the QUADRA DN4 hose. For large scale production it is now possible to use the new worktop crimper RXA006-RXA008 which easily crimps the fittings for QUADRA DN2, DN4 e DN6 hoses.



QUADRA: DN2

QUADRA: DN4



QUADRA: DN6

QUADRA: ACCESSORIES

QUADRA: PACKAGES

TECHNICAL DATA

PERFORMANCE and condition of use

part number	Pack	DN	OD mm	WP		BP		WT		BEND RADIUS mm	CRIMPING DIAMETER Ø mm	CRIMPING DIAMETER Ø mm	CRIMPING DIAMETER Ø		
				bar	MPa	psi	bar	MPa	psi					min °C	max °C
0786C 0786BC	 50 m	DN6	10,9	120	12,0	1740	600	60	8700	-45°	+130°	35	NA	12,4 ±0,1	12,4 ±0,2
0786K 0786BK	 10 m														

Classification of QUADRA capillary hoses according to Directive 97/23/CE

PART NUMBER	CLASSIFICATION
0786C 0786BC 0786K 0786BK	paragraph 3 article 3

PERMITTED FLUIDS

Type of Gas	Type of Oil
HFC (R134a, R404A, R407A, R407B, R407C, R410A, R507)	polyol ester based
HCFC (R22)	mineral oils
CO ₂	polyol ester based

Assembly instructions for crimping fittings for QUADRA DN6 capillary hose

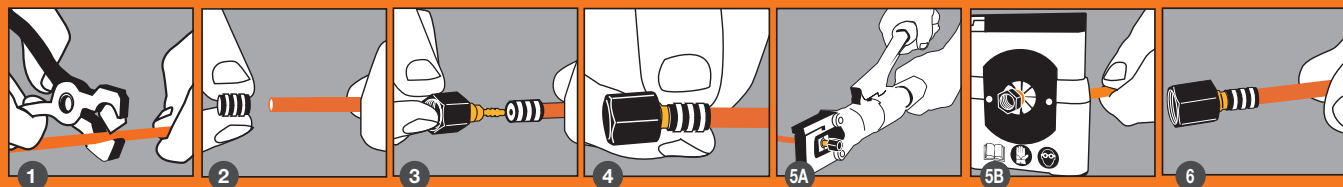

Cut the QUADRA capillary hose to the required length using the special WXA004 cutter.

Slip the nut over the hose (depending on fitting type). Ensure that the threaded side is pointing towards the end of the hose that needs assembling.

Assemble the insert together with the nut onto the hose end.

Pay attention not to move the components already fitted and slide the ferrule over the hose towards the insert positioning it in line with the insert.

Crimp the ferrule with our hand pliers type RXA005, up to the limit stop of the pliers: once the optimal deformation has been achieved the pliers will open automatically.

Crimp the ferrule with our crimper RXA006-RXA008. Keep the lever pulled. Once the optimal deformation has been achieved the crimper will stop automatically.

The assembling is finished and the eventual nut can easily slide over the ferrule: check the correct positioning of the components and make sure the entire surface of the ferrule has been swaged.



Note:

ATTENTION: Once the hose assembly connected to the machine, do not move or rotate it, otherwise you risk loosening the nut or damaging the fitting by compromising its tightness. In case you have to modify the orientation of the coupling, unscrew the nut, position the hose assembly, then tighten the nut again respecting the torque value of min 20 Nm, max 25 Nm.

1/4 SAE Straight Female Fitting



Part number	XBA02N	WBA02N	KBA02N
Pack	50 pcs	50 pcs	10 pcs
Copper gasket			

3/8 SAE Straight Female Fitting

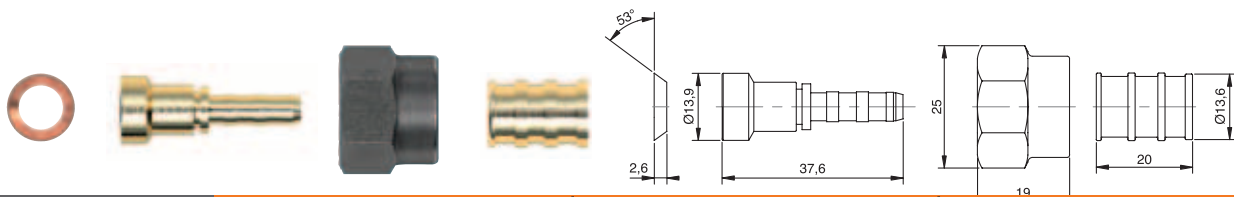

Part number	XBA04N	WBA04N	KBA04N
Pack	50 pcs	50 pcs	10 pcs
Copper gasket			

1/4 SAE Elbow Female 90°

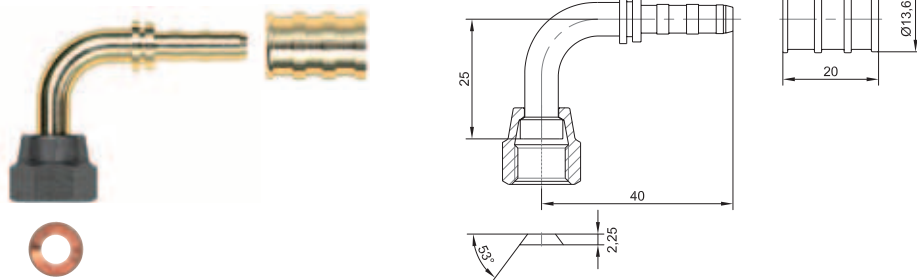

Part number	XCA02N	WCA02N	KCA02N
Pack	50 pcs	50 pcs	10 pcs
Copper gasket			

QUADRA: DN2

QUADRA: DN4

QUADRA: DN6

QUADRA: ACCESSORIES

QUADRA: PACKAGES

QUADRA DN6 fittings

3/8 SAE Elbow Female 90°

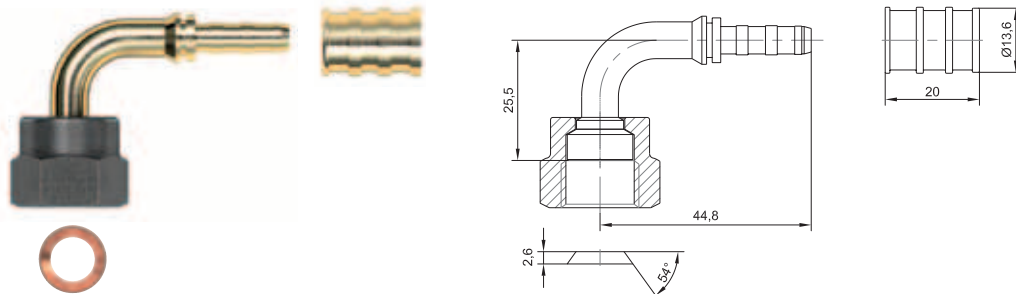

Part number	XCA04N	WCA04N	KCA04N
Pack	50 pcs	50 pcs	10 pcs
Copper gasket			

Copper Brazieng Fitting (6x8x100 mm)

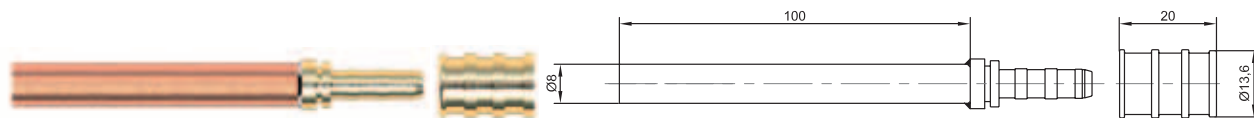

Part number	WZE2N1
Pack	50 pcs

QUADRA DN6 fittings

HYDRAULIC PLIERS



Part number	RXA005
Pack	1 pcs

CUTTER AND BLADES

Cutter



Part number	WXA004	WXB004
Pack	1 pcs	2 pcs

VALVE OPENER, GASKET AND NUT CAPS

Copper gasket 1/4



Copper gasket 3/8



QUADRA 1/4 fitting plugs

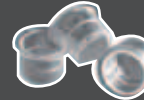

QUADRA 3/8 fitting plugs

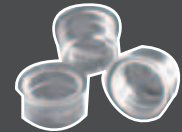

Part number	WRP502	WRP504	WRW912	WRW914
Pack	50 pcs	50 pcs	50 pcs	50 pcs

QUADRA-CRIMP

details on page 52



Part number	RXA006 RXA008
Pack	1 pcs

QUADRA CASE

Empty



Part number	MRO43
Pack	1 pcs

QUADRA: DN2

QUADRA: DN4

QUADRA: DN6



QUADRA: ACCESSORIES



QUADRA: PACKAGES

QUADRA DN6 assembled capillary hoses

Straight Female 1/4 + Straight Female 1/4

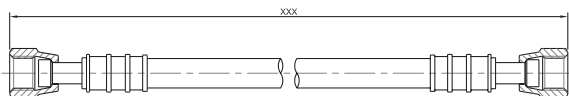

Part number

CDZXXX

CEAXXX

Pack



Straight Female 1/4 + Straight Female 3/8

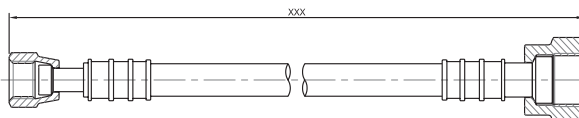

Part number

CD4XXX

CEEXXX

Pack



Straight Female 1/4 + Elbow Female 90° 1/4

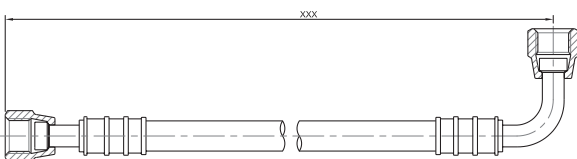

Part number

CD1XXX

CEBXXX

Pack



Straight Female 1/4 + Elbow Female 90° 3/8

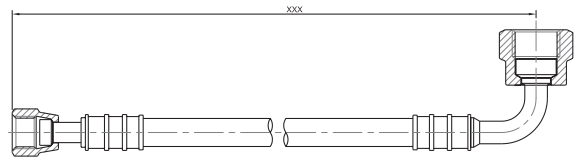

Part number

CD7XXX

CEHXXX

Pack



Straight Female 1/4 + Copper brazing tube

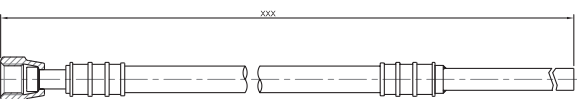

Part number

CHLXXX

CHMXXX

Pack



Elbow Female 90° 1/4 + Elbow Female 90° 1/4

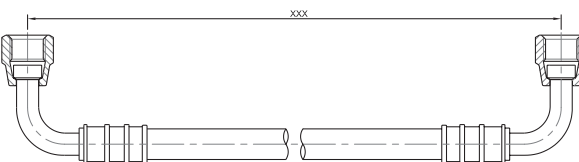

Part number

CD2XXX

CECXXX

Pack



Elbow Female 90° 1/4 + Elbow Female 90° 3/8

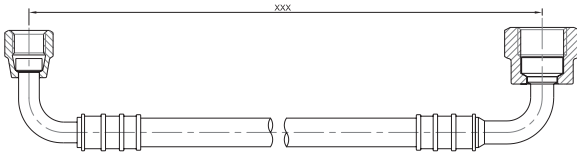

Part number

CD8XXX

CEIXXX

Pack



Elbow Female 90° 1/4 + Copper brazing tube

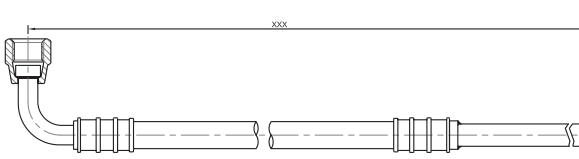

Part number

CHPXXX

CHQXXX

Pack



QUADRA DN6 assembled capillary hoses

Straight Female 3/8 + Straight Female 3/8

Part number	CD3XXX	CEDXXX
Pack	50 pcs	50 pcs

Straight Female 3/8 + Elbow Female 90° 1/4

Part number	CD5XXX	CEFXXX
Pack	50 pcs	50 pcs

Straight Female 3/8 + Elbow Female 90° 3/8

Part number	CD6XXX	CEGXXX
Pack	50 pcs	50 pcs

Straight Female 3/8 + Copper brazing tube

Part number	CHNXXX	CHOXXX
Pack	50 pcs	50 pcs

Elbow Female 90° 3/8 + Elbow Female 90° 3/8

Part number	CD9XXX	CEJXXX
Pack	50 pcs	50 pcs

Elbow Female 90° 3/8 + Copper brazing tube

Part number	CHRXXX	CHSXXX
Pack	50 pcs	50 pcs

Copper brazing tube + Copper brazing tube

Part number	CHTXXX	CHUXXX
Pack	50 pcs	50 pcs

- QUADRA orange
 - QUADRA black
 XXX - total length of QUADRA capillary hose in cm (multiple lengths of 10 cm)

QUADRA CRIMP

THE NEW PROFESSIONAL QUADRA-CRIMP

QUADRA-CRIMP

QUADRA™ CRIMP is the new professional bench press that is both simple to use and versatile. The heart of the machine is a central control mechanism for greater accuracy during the crimping operation with immediate release of the dies when exact crimping diameter has been achieved. QUADRA™ CRIMP simplifies the steps to obtain a correct assembly of QUADRA™ products, which can be summarized as follows:

- 1** Connect the machine to an outlet of compressed air, through the adapter (female 1/4"), with the pneumatic quick coupling which is supplied together with the press.
- 2** Insert into the crimping head the dies (held in place magnetically) that is suitable for capillary that will be assembled. (supplied with the press, Q2-Q4-Q6 is embossed to better distinguish the set of punches to be used for capillaries™ QUADRA DN2-DN4 or DN6).
- 3** Insert the capillary hose to be crimped into the head.
- 4** Move the knob to the right until it reaches the limit. The machine is set to stop automatically when the correct crimping specification is achieved. You can also use the machine through a foot operated pedal so that you have free use of both hands during pressing operations.
- 4 b** After having switched the command to the pedal, push the back of the pedal all the way down with your heel to start the crimping then, after the hose is crimped, push the front of the pedal all the way down to open the dies.



QUADRA CRIMP
RXA006-RXA008

THE PRESS IS SUPPLIED IN A PACKAGE THAT INCLUDES:

- ▶ Hydraulic crimper.
- ▶ Carter ABS with internal air-hydraulic pump.
- ▶ Adapter (1/4" female) for quick pneumatic coupler.
- ▶ 3 series of dies (Q2-Q4-Q6).
- ▶ Control pedal kit (optional when purchasing the sole press RXA006).
- ▶ Instruction Manual.

QUADRA™ CRIMP

has a protective outer body that protects the operator and the machine from inappropriate use of the crimper and, thanks to the carrying handles, the crimper can be easily moved. The crimping head swivels 360° to allow the best working position for the operator. The functioning of both the press and the pedal is by compressed air connection 500 ÷ 800 kPa [5 ÷ 8 bar, 72 ÷ 116 psi] (via convenient quick coupling connections). To help operation and maintenance of the machine there has been added an oil level inspection cap, with dipstick, indicating MIN MAX. There are stickers explaining the functioning of all parts of the machine.

Attached to the machine is a detailed instruction manual with extensive descriptions of the operation and maintenance.

Note: The optional foot pedal RXB008 can be installed only on the new version of the press unit provided with a central internal control which is missing in the old version of the press.

Available Version

QUADRA™ CRIMP

is available in two versions:

- ▶ **RXA008** with foot operated pedal to have free use of both hands during pressing operations.
- ▶ **RXA006** without foot pedal.



COR-SAFE PF - COR-SAFE PF



050



Abrasion and chemical resistant corrugated hose protector / conduit

part number	hose size		ID		OD		weight	
	DN	inch	mm	inch	mm	inch	g/m	lbs/ft
059A	DN16	5/8	16,0	0,630	21,6	0,850	60	0,040
059B	DN22	7/8	22,3	0,878	28,5	1,122	110	0,074
059C	DN29	1-1/8	29,2	1,150	36,0	1,417	130	0,087
059D	DN39	1-1/2	39,6	1,559	46,6	1,835	160	0,108
059E	DN55	2-1/8	55,2	2,173	64,0	2,520	280	0,188

ABRASION AND CHEMICAL RESISTANT CORRUGATED HOSE PROTECTOR / CONDUIT

A hose and cable protector system with a large temperature range and exceptional wear and chemical resistance features for the hardest applications, while still maintaining a high degree of flexibility through the corrugated design.

The polyester material (high performance engineering polymer) makes it the ideal choice for hose and cable systems that operate in low temperature environment without losing the flexibility of the hose assembly. If the entire length of hose or bundles needs to be protected from outside possible hazardous substances.

CUTTER AND BLADES

Cutter



Cutter blades



Part number

WXA004

WXB004

Pack



HAND PLIERS FOR DN2 HOSES



Part number

RXA007

Pack



ACCESSORIES FOR QUADRA HOSES

QUADRA-CRIMP FOR DN2-DN4-DN6 HOSES



Part number	RXA006 RXA008
Pack	 1 pcs

HYDRAULIC PLIERS FOR DN4-DN6 HOSES



Part number	RXA005
Pack	 1 pcs

VALVE OPENER, GASKET AND NUT CAPS

Removable valve opener



Copper gasket 1/4



Copper gasket 3/8





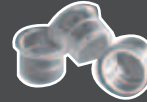

QUADRA 1/4 fitting plugs



QUADRA 3/8 fitting plugs



Part number	WTD2Z1	WRP502	WRP504	WRW912	WRW914
Pack	 50 pcs	 50 pcs	 50 pcs	 50 pcs	 50 pcs

QUADRA-CLAMPS FOR DN2-DN4-DN6 HOSES

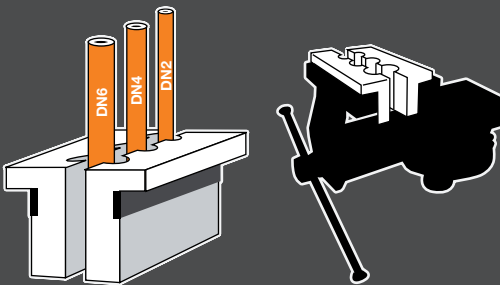

Part number	RXB007
Pack	 1 pcs

QUADRA CASE



- 10 m. ref. 0780K
- 10 m. ref. 0780BK
- 20 ref. WBA02C
- 20 ref. WBB02C
- 10 ref. WCA02C
- 10 ref. WPB0C1
- 10 ref. WPB0C2
- 50 ref. WRP502
- 50 ref. WTD2Z1
- 1 ref. RXA007
- 1 ref. RXA004
- 1 ref. WXB004

Part number	MRO43	W00001
Pack	 1 pcs	 1 pcs

QUADRA:  DN2

QUADRA:  DN4

QUADRA:  DN6

QUADRA:  ACCESSORIES

QUADRA:  PACKAGES

QUADRA PACKAGES

THE NEW QUADRA PACKAGES

Born to make life easier for the retailer and the customer alike, the new Quadra packages widen the range, making it even more functional and adaptable in any sales context and any kind of use.

Not all customers are interested in purchasing large quantities of materials, and the chance to buy smaller product quantities makes the Quadra range appealing even for installers and small builders.

The products are also available in new blister packs, bags and boxes.





The new packaging is not only easy to use but are also very attractive.

The graphics and colours used make them very effective.

Their high impact graphics make them easily recognizable and identifiable.

The new packages are perfect for putting on display, clearly displaying the products to the public.

KEY PACKAGES QUADRA PRODUCTS

HOSES	
 50 m	QUADRA hose LOOSE in 50 m roll
 10 m	QUADRA hose PACKAGED IN BAGS 10 m roll
FITTINGS	
 n. pcs	QUADRA fittings PACKAGED IN BOXES 50 pieces*
 10 pcs	QUADRA fittings PACKAGED IN BLISTER PACKS 10 pieces
ACCESSORIES AND ASSEMBLED HOSES	
 n. pcs	QUADRA accessories and assembled hoses PACKAGED IN BAGS

* reusable fittings are distributed in packs of 25



Small and large quantities for better service

FLOOR DISPLAY UNIT FOR BLISTER PACKS AND BAGS

Floor display unit, aluminium profile, orange background, holds an assortment of Quadra products and accessories, packaged in blister packs and bags. The display unit is complete with a series of products that can be easily re-stocked.

THE DISPLAY UNIT SPECIFICALLY INCLUDES:

- ▶ 4 ten-piece blister packs including every type of DN2 and DN4 fittings
- ▶ 4 two-piece bags of extra cutter blades
- ▶ 4 fifty-piece packs of copper gaskets
- ▶ 4 fifty-piece packs of valve openers
- ▶ 4 cutters
- ▶ 4 hand pliers
- ▶ 4 10 meter rolls of orange DN2 capillary hoses
- ▶ 4 10 meter rolls of black DN2 capillary hoses
- ▶ 4 10 meter rolls of orange DN4 capillary hoses
- ▶ 4 10 meter rolls of black DN4 capillary hoses

Display unit size
width: 69 cm
height: 214 cm
max. depth: 50 cm



QUADRA DISPLAY UNITS QUADRA

W00004	QUADRA complete floor display unit
W00000	QUADRA counter display unit
X00000	QUADRA counter display unit (with copper gasket)

The range of assembled hoses
for air conditioning and refrigeration,
tailor made for every needs

INFINITY

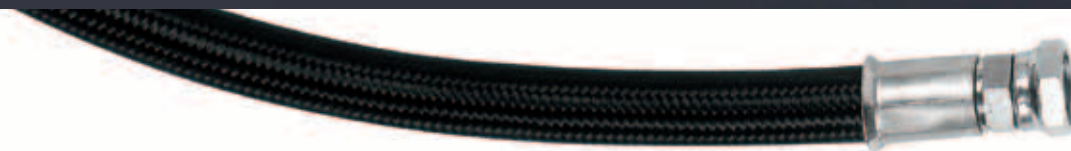

PLASTIC CONVOLUTED HOSE



**Silent,
resistant, flexible**

**Infinite advantages for
air conditioning
and refrigeration**

**The flexible
thermoplastic system
that fits any circuit**



INFINITY
PLASTIC CONVOLUTED HOSE



PLASTIC CAPILLARY HOSE **QUADRA:**

PLASTIC CONVOLUTED HOSE **INFINITY**

PLASTIC VIBRATION ABSORBER **ZERO**



INFINITY

PLASTIC CONVOLUTED HOSE



All INFINITY hoses now can be used with CO₂ up to 50 bar / 724 psi from -45°C up to +130°C / from -49°F up to +266°F.



Directive 2002/95/EC

“Restriction of the use of certain hazardous substances in electrical and electronic equipment”

All INFINITY products meet the minimum requirements of the RoHS directive.

Inner tube material 1

Thermoplastic polymer.

Reinforcing material 2

Polyester braid of high tensile strength with high modulus.

Cover material 3

Black polyester braid of high textile strength, abrasion resistant.

INFINITY

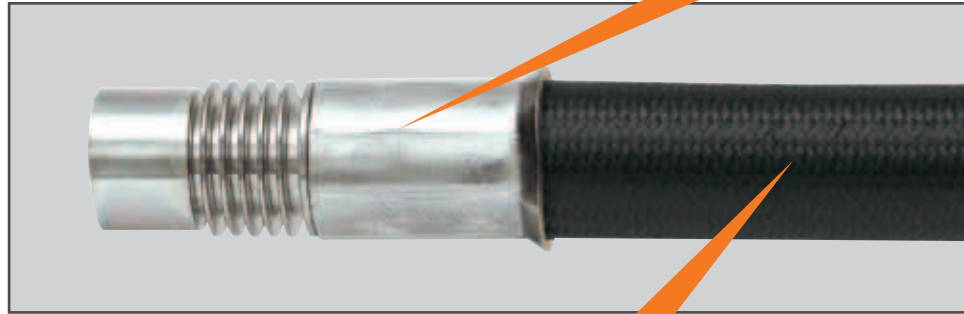

The reinforcing layers are made of stress-resistant polyester fibre.

The external cover is made of anti-abrasion materials.

INFINITY can be applied to refrigeration and air conditioning systems and is compatible with cooling fluids in the HCFC, HFC families.

INFINITY KEY-ELEMENTS

THE BRAZING FITTING

INFINITY convoluted hose for cooling systems is equipped with a brazing fitting patented by Transfer Oil (patent no.1326357).

The fitting couplings are pre-set for heat dissipation, thanks to the radiator, which facilitates and simplifies the brazing operation, eliminating the need for supplementary auxiliary cooling systems.

The lateral fins, which vary according to the hose diameter, are used to dissipate the heat before it damages the thermoplastic hose the fitting is connected to.

Tests show that under normal environmental and time conditions, they never exceed 90°C at the point of coupling between the hose and the fitting.

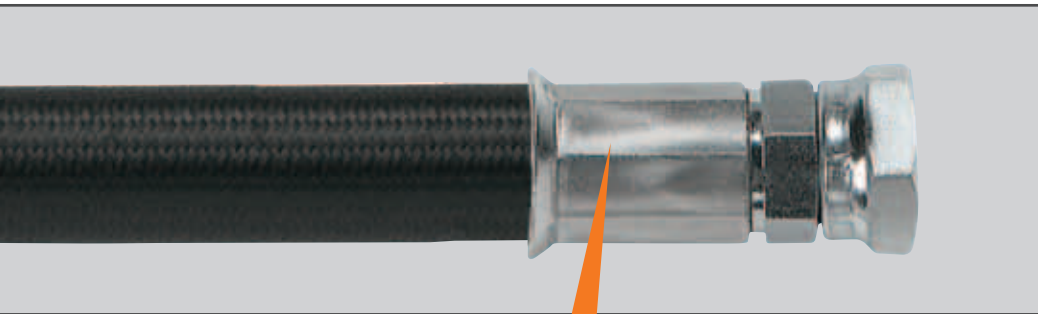

THE ROTALOCK FITTING

The Infinity hose with Rotalock fitting enables to make fast and safe connections without the use of any welding.

Rotalock fittings are available in different sizes.

INFINITY is supplied with either brazing fittings or Rotalock screw fittings. Design and manufacturing of the hose are in compliance with DIR 97/23/EC "Pressure equipment".



Classification of Infinity hose
according to Directive 97/23/CE

DN	Classifications
15-21-28	paragraph 3 article 3
38-54	category I (marking CE)



TECHNICAL DATA BRAZING FITTING

INFINITY

PLASTIC CONVOLUTED HOSE

Brazing fitting assembly instructions

Once the copper tube of suitable diameter has been fitted in the brazing fitting, heat the two ends until the filler material begins to melt.

Continue the brazing around the whole circumference of the brazing fitting.

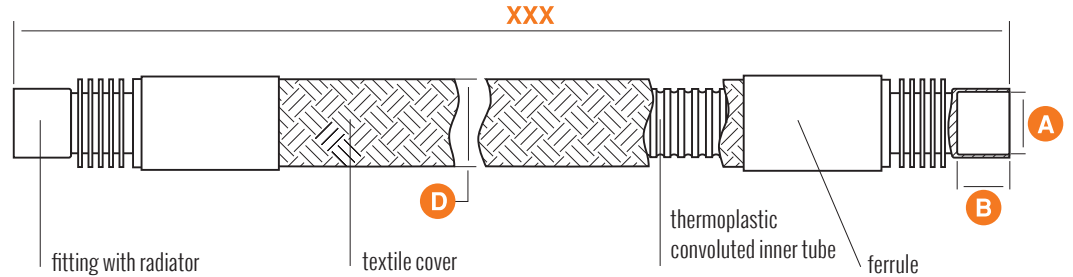

INFINITY HOSE with brazing metric fitting

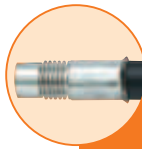

part number	DN	A for tube O.D. (mm)	B mm	D mm	Minimum bending radius
-------------	----	-------------------------	---------	---------	------------------------

CA1XXX	15	12	12	24	15
CA2XXX	15	16	15	24	15
CA3XXX	21	18	17	31	30
CA4XXX	21	22	19	31	30
CA5XXX	28	28	24	39	40
CA6XXX	38	35	30	49	80
CA7XXX	38	42	38	49	80
CA8XXX	54	54	48	69	110

INFINITY HOSE with brazing inch fitting

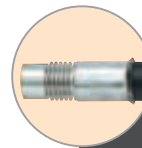

part number	DN	A for tube O.D. (inches)	B mm	D mm	Minimum bending radius
-------------	----	-----------------------------	---------	---------	------------------------

CARXXX	15	1/2	12	24	15
CASXXX	15	5/8	15	24	15
CATXXX	21	3/4	17	31	30
CAUXXX	21	7/8	19	31	30
CAVXXX	28	1-1/8	24	39	40
CAWXXX	38	1-3/8	30	49	80
CAXXXX	38	1-5/8	38	49	80
CAYXXX	54	2-1/8	48	69	110



1 insert the copper tube



2 heat the two ends



3 start brazing around the whole circumference

XXX total length of INFINITY hose in cm (multiple lengths of 10 cm)

TECHNICAL DATA BRAZING FITTING

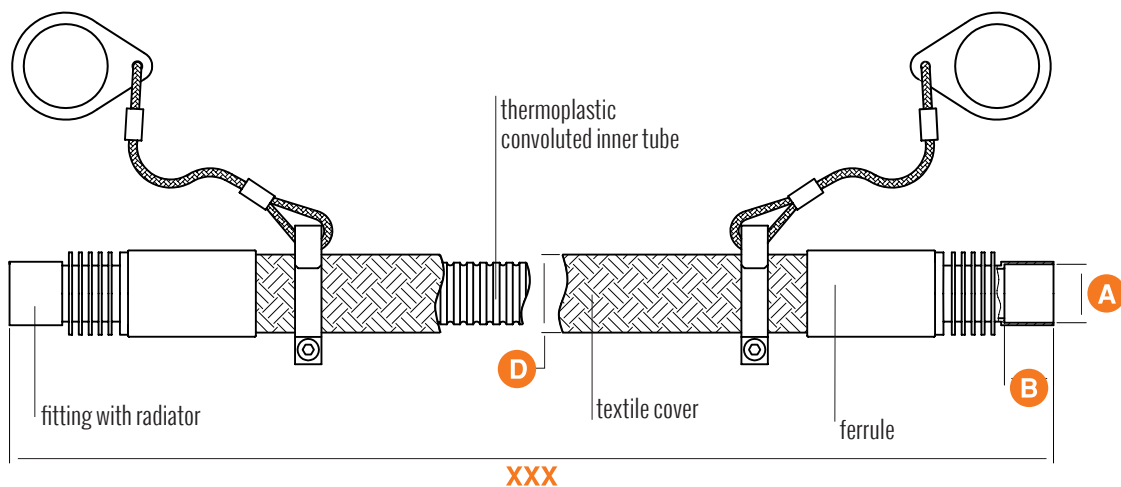

INFINITY HOSE with brazing metric fitting (with safety clamp)

part number	DN	A for tube O.D. (mm)	B mm	D mm	Minimum bending radius
-------------	----	-------------------------	---------	---------	------------------------

CB1XXX	15	12	12	24	15
CB2XXX	15	16	15	24	15
CB3XXX	21	18	17	31	30
CB4XXX	21	22	19	31	30
CB5XXX	28	28	24	39	40
CB6XXX	38	35	30	49	80
CB7XXX	38	42	38	49	80
CB8XXX	54	54	48	69	110

INFINITY HOSE with brazing inch fitting (with safety clamp)

part number	DN	A for tube O.D. (inches)	B mm	D mm	Minimum bending radius
-------------	----	-----------------------------	---------	---------	------------------------

CBRXXX	15	1/2	12	24	15
CBSXXX	15	5/8	15	24	15
CBTXXX	21	3/4	17	31	30
CBUXXX	21	7/8	19	31	30
CBVXXX	28	1-1/8	24	39	40
CBWXXX	38	1-3/8	30	49	80
CBXXX	38	1-5/8	38	49	80
CBYXXX	54	2-1/8	48	69	110

XXX total length of INFINITY hose in cm (multiple lengths of 10 cm)





TECHNICAL DATA ROTALOCK FITTING

INFINITY

PLASTIC CONVOLUTED HOSE

Rotalock fitting assembly instructions



1 Position the fitting near the male coupling.



2 Screw the fitting thread onto the male fitting, clockwise by hand for the first few turns.



3 Screw on fully in a clockwise direction using spanners and counter spanners.

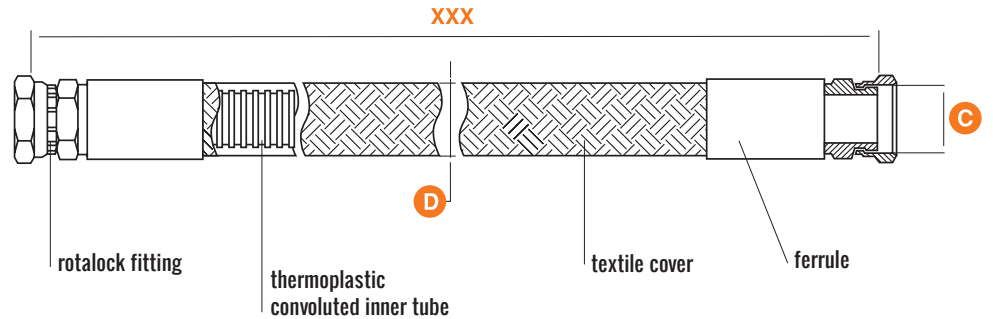

INFINITY HOSE with rotalock fitting

part number	DN	C ROTALOCK (inches)	D mm	Minimum bending radius
CAIXXX	15	1	24	15
CAKXXX	21	1-1/4	31	30
CAMXXX	28	1-3/4	39	40
CANXXX	38	1-3/4	49	80
CAQXXX	54	2-1/4	69	110

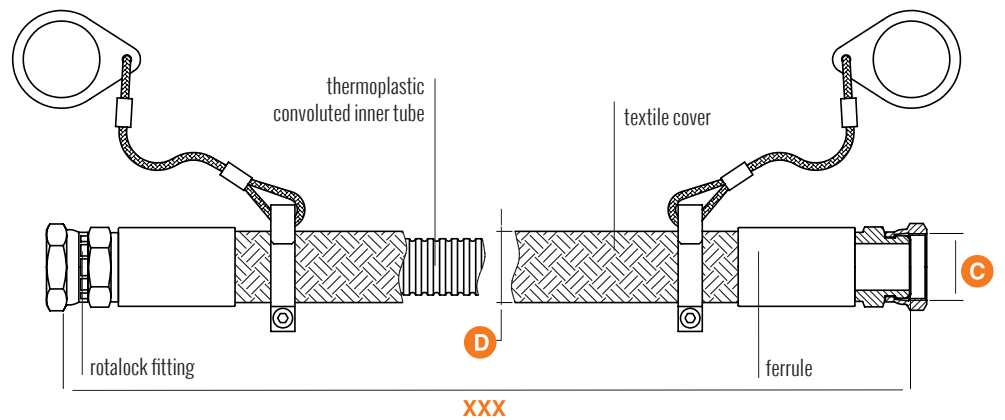

INFINITY HOSE with rotalock fitting (with safety clamp)

part number	DN	C ROTALOCK (inches)	D mm	Minimum bending radius
CBIXXX	15	1	24	15
CBKXXX	21	1-1/4	31	30
CBMXXX	28	1-3/4	39	40
CBNXXX	38	1-3/4	49	80
CBQXXX	54	2-1/4	69	110

TECHNICAL DATA BRAZING/ROTALOCK FITTING

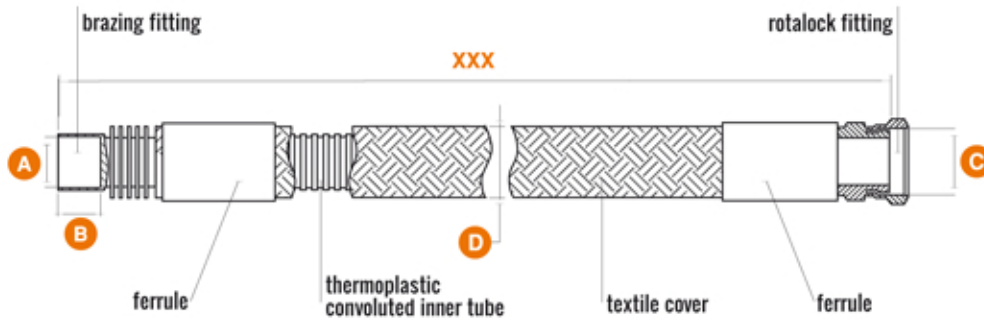

INFINITY HOSE with Rotalock fitting and brazing metric fitting

part number	DN	A for tube O.D. (mm)	B mm	C inches	D mm	Minimum bending radius mm
CCRXXX	15	12	12	1	24	15
CCSXXX	15	16	15	1	24	15
CCTXXX	21	18	17	1-1/4	31	30
CCUXXX	21	22	19	1-1/4	31	30
CCVXXX	28	28	24	1-3/4	39	40
CCWXXX	38	35	30	1-3/4	49	80
CCXXX	38	42	38	1-3/4	49	80
CCYXXX	54	54	48	2-1/4	69	110

INFINITY HOSE with Rotalock fitting and brazing inch fitting

part number	DN	A for tube O.D. (inches)	B mm	C inches	D mm	Minimum bending radius mm
CC1XXX	15	1/2	12	1	24	15
CC2XXX	15	5/8	15	1	24	15
CC3XXX	21	3/4	17	1-1/4	31	30
CC4XXX	21	7/8	19	1-1/4	31	30
CC5XXX	28	1-1/8	24	1-3/4	39	40
CC6XXX	38	1-3/8	30	1-3/4	49	80
CC7XXX	38	1-5/8	38	1-3/4	49	80
CC8XXX	54	2-1/8	48	2-1/4	69	110

XXX total length of INFINITY hose in cm (multiple lengths of 10 cm)



TECHNICAL DATA BRAZING/ROTALOCK FITTING

INFINITY

PLASTIC CONVOLUTED HOSE

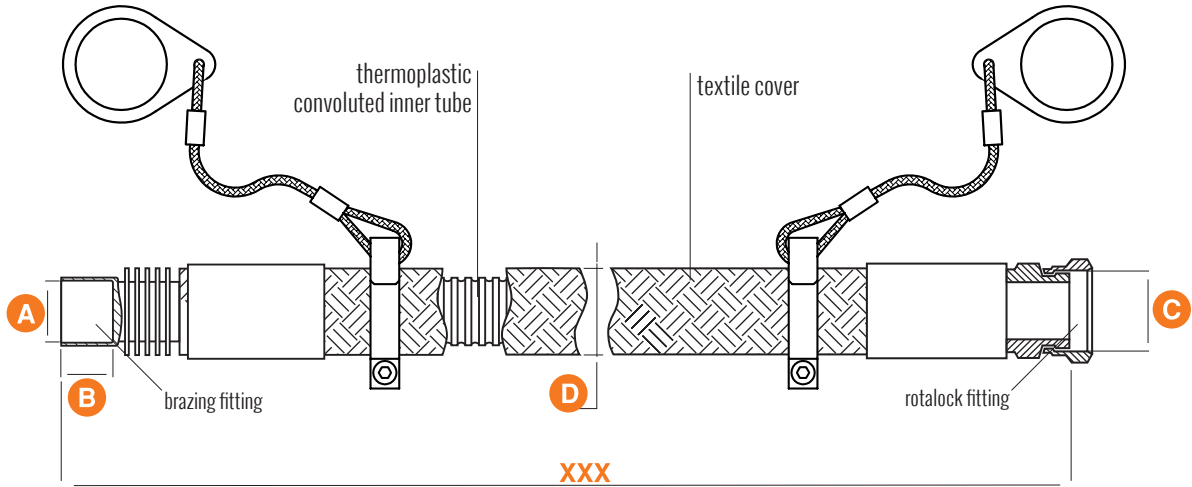

INFINITY HOSE with Rotalock fitting and brazing metric fitting (with safety clamp)

part number	DN	A for tube O.D. (mm)	B mm	C inches	D mm	Minimum bending radius mm
CDAXXX	15	12	12	1	24	15
CDBXXX	15	16	15	1	24	15
CDCXXX	21	18	17	1-1/4	31	30
CDDXXX	21	22	19	1-1/4	31	30
CDEXXX	28	28	24	1-3/4	39	40
CDFXML	38	35	30	1-3/4	49	80
CDGXXX	38	42	38	1-3/4	49	80
CDHXXX	54	54	48	2-1/4	69	110

INFINITY HOSE with Rotalock fitting and brazing inch fitting (with safety clamp)

part number	DN	A for tube O.D. (inches)	B mm	C inches	D mm	Minimum bending radius mm
CDIXXX	15	1/2	12	1	24	15
CDJXXX	15	5/8	15	1	24	15
CDKXXX	21	3/4	17	1-1/4	31	30
CDLXXX	21	7/8	19	1-1/4	31	30
CDMXXX	28	1-1/8	24	1-3/4	39	40
CDNXXX	38	1-3/8	30	1-3/4	49	80
CDPXXX	38	1-5/8	38	1-3/4	49	80
CDQXXX	54	2-1/8	48	2-1/4	69	110

PERFORMANCE AND CONDITION OF USE

INFINITY hose fittings

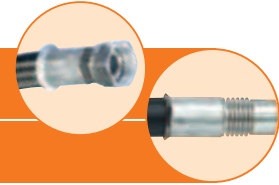

fitting type	material used	surface treat.	coupling process to be used for installation	filler material for installation
brazing fittings with heat dissipator radiator (Patent no.1326357 released 21/01/05)	drawn steel	zinc plating	hard brazing	silver alloy with low melting point
Rotalock	drawn steel	zinc plating	screw-on	none



PERMEABILITY

The permeability value provides an indication of the maximum leakage at constant conditions of use of the hose at 100°C for a whole year. The real permeability value must therefore be measured considering the effective working times and temperatures to which the hose is subjected, remembering that significant and detectable values are obtained with temperatures of more than 50°C and that the permeability increases proportionally to the temperature. The permeability values obtained at 100°C for the GOMAX hose range, of approximately 1 kg/m²/year, are much lower than those set in the standard UNI EN 1736, which foresees a maximum permeability value of 5 kg/m²/year.

PERFORMANCE and condition of use

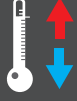
WP 			BP 			WT 	
max working pressure			min. bursting pressure			allowable temp.	
bar	MPa	psi	bar	MPa	psi	min °C	max °C
50	5,0	724	250	25	3620	-45°	+110°

* Peak temperature +130°C

PERMITTED FLUIDS

Type of Gas	Type of Oil
HFC (R134a, R404A, R407A, R407B, R407C, R410A, R507)	polyol ester based
HCFC (R22)	mineral oils
CO2	polyol ester based

PRESSURE DROP and permeability

DN	Pressure Drop				Permeability at 100°C	
	(bar/m)				(g/year)	
	10 m ³ /h	20 m ³ /h	50 m ³ /h	100 m ³ /h	R134a	R407C
15	0,0318	0,1275			52	73
21	0,0059	0,0237			70	97
28		0,0056	0,0348		89	123
38			0,0076	0,0304	78	110
54			0,0053	0,0014	112	156

PRESSURE DROP

The values refer to measurements performed by use of air on 1 m length of INFINITY hose.

Thermoplastic and
vibration-proof for air conditioning
and refrigeration systems

ZERO



PLASTIC VIBRATION ABSORBER





**Thermoplastic, flexible
and reliable**

**Equipped with brazing fittings
with heat dissipator**

**Made of anti-abrasion
material**

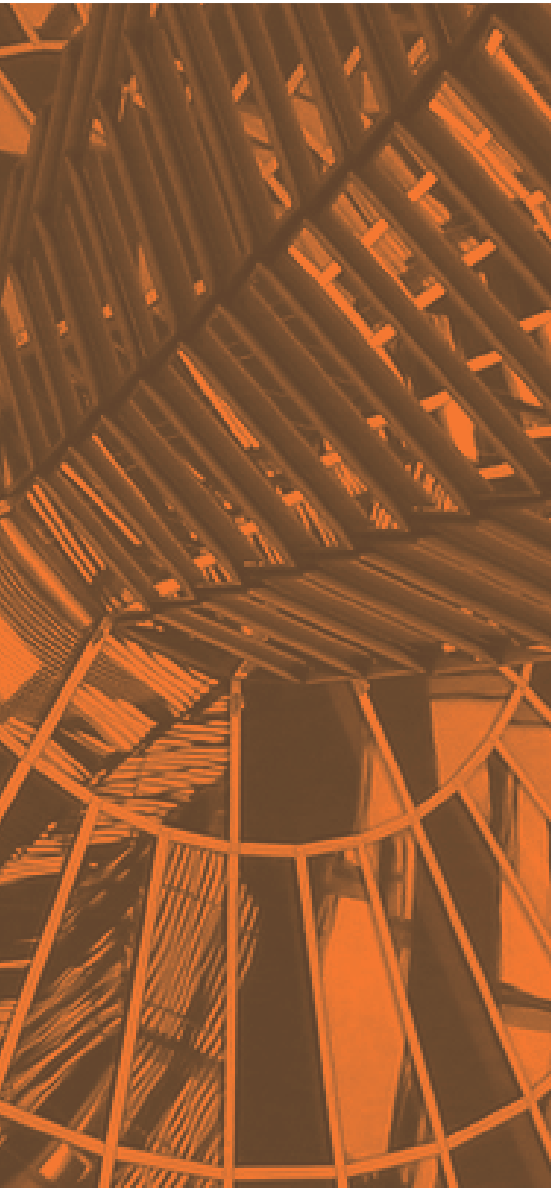

ZERO

PLASTIC VIBRATION ABSORBER

PLASTIC CAPILLARY HOSE **QUADRA**

PLASTIC CONVOLUTED HOSE **INFINITY**

PLASTIC VIBRATION ABSORBER **ZERO**



ZERO

PLASTIC VIBRATION ABSORBER

All ZERO hoses now can be used with CO₂ up to 50 bar / 724 psi from -45°C up to +130°C / from -49°F up to +266°F.



Directive 2002/95/EC

“Restriction of the use of certain hazardous substances in electrical and electronic equipment”

All ZERO products meet the minimum requirements of the RoHS directive.



The reinforcing layers are made of stress-resistant polyester fibre, while the external cover is made of anti-abrasion materials. ZERO can be applied to refrigeration and air conditioning systems and is compatible with cooling fluids in the HCFC, HFC families.

Inner tube material

1

Thermoplastic polymer.

Reinforcing material

2

Polyester braid of high tensile strength with high modulus.

Cover material

3

Black polyester braid of high textile strength, abrasion resistant.

The tests carried out by Transfer Oil involve the comparison of two systems: ZERO and the traditional metal anti-vibration system. Under equal conditions of disturbing acoustic and sub-acoustic frequencies, ZERO is much better at absorbing vibrations than other types of anti-vibration systems.

Vibration-proof ZERO

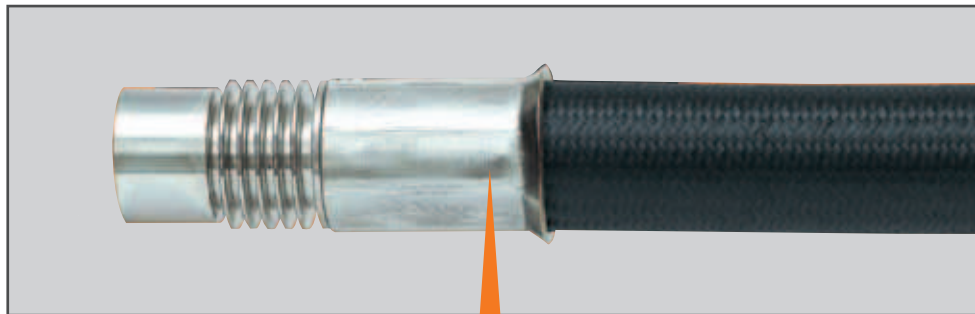

Thermoplastic material

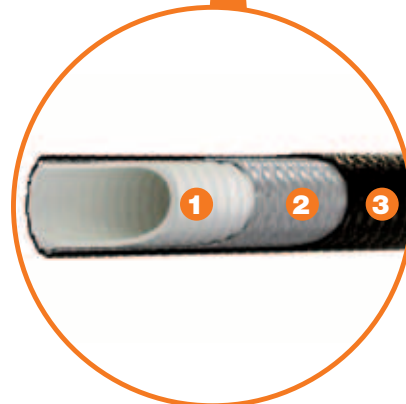

THE BRAZING FITTING

The ZERO vibration absorber is fitted with a brazing fitting patented by Transfer Oil (patent no.1326357).

The couplings are pre-set for heat dissipation, thanks to the radiator, which facilitates and simplifies the brazing operation eliminating the need for auxiliary cooling systems. The lateral fins, which vary according to the hose diameter, are used to dissipate the heat before it damages the thermoplastic hose the fitting is connected to. Tests show that under normal environmental and time conditions, in the brazing phase, they never exceed 90°C at the point of coupling between the hose and the fitting.



the brazing fitting

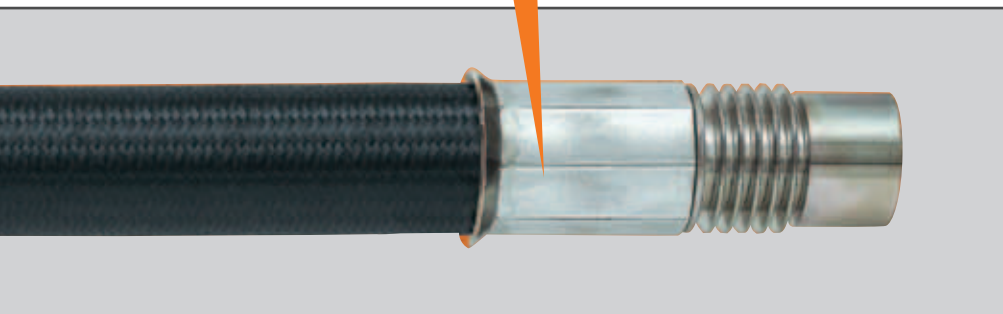

Classification of Zero hose
according to Directive 97/23/CE

DN	Classifications
15-21-28	paragraph 3 article 3
38-54	category I (marking CE)

Brazing fitting assembly instructions

Once the copper tube of suitable diameter has been fitted in the brazing fitting, heat the two ends until the filler material begins to melt. Continue the brazing around the whole circumference of the brazing fitting.

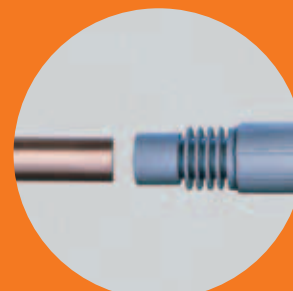

1 Insert the copper tube



2 heat the two ends



3 start brazing around the whole circumference



TECHNICAL DATA

ZERO

PLASTIC VIBRATION ABSORBER

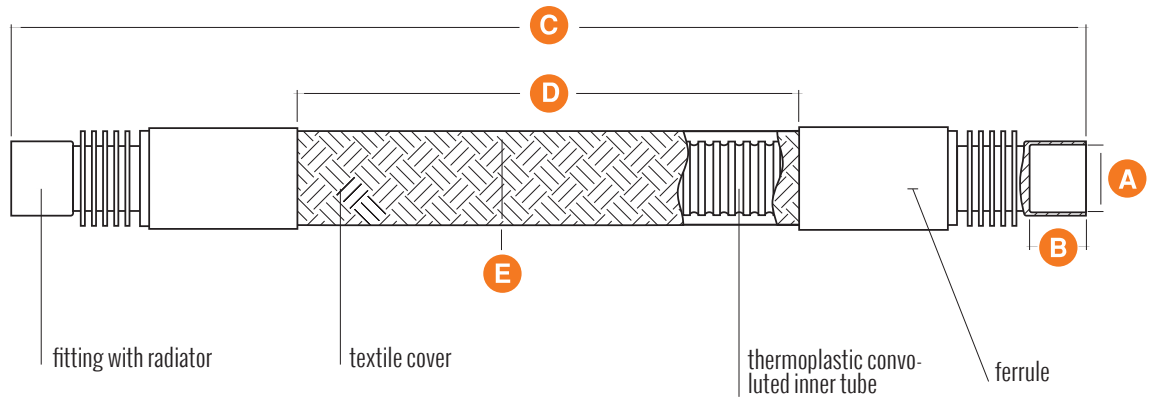

ZERO VIBRATION ABSORBER with brazing metric fitting

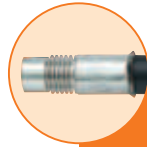

part number	DN	A for tube O.D. (mm)	B mm	C mm	D mm	E mm	Weight Kg
C9M12	15	12	12	332	170	24	0,28
C9M16	15	16	15	340	170	24	0,29
C9M18	21	18	17	397	200	31	0,58
C9M22	21	22	19	401	200	31	0,58
C9M28	28	28	24	499	260	39	0,93
C9M35	38	35	30	559	260	49	1,68
C9M42	38	42	38	577	260	49	1,73
C9M54	54	54	48	635	260	69	3,44

ZERO VIBRATION ABSORBER with brazing inch fitting

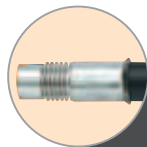

part number codice	DN	A for tube O.D. (inches)	B mm	C mm	D mm	E mm	Weight Kg
C9I12	15	1/2	12	332	170	24	0,28
C9I16	15	5/8	15	340	170	24	0,29
C9I18	21	3/4	17	397	200	31	0,58
C9I22	21	7/8	19	401	200	31	0,58
C9I28	28	1-1/8	24	499	260	39	0,93
C9I35	38	1-3/8	30	559	260	49	1,68
C9I42	38	1-5/8	38	577	260	49	1,73
C9I54	54	2-1/8	48	635	260	69	3,44



PERFORMANCE AND CONDITION OF USE

FITTINGS in the ZERO vibration absorber range

fitting type	material used	surface treatment	coupling process to be used for installation	filler material for installation
brazing fittings with heat dissipator radiator (Patent no.1326357 released 21/01/05)	drawn steel	zinc plating	hard brazing	silver alloy with low melting point



PERFORMANCE and condition of use

WP 			BP 			WT 	
max working pressure			min. bursting pressure			allowable temp.	
bar	MPa	psi	bar	MPa	psi	min °C	max °C
50	5,0	724	250	25	3620	-45°	+110°

* Peak temperature +130°C

PERMITTED FLUIDS

Type of Gas	Type of Oil
HFC (R134a, R404A, R407A, R407B, R407C, R410A, R507)	polyol ester based
HCFC (R22)	mineral oils
CO2	polyol ester based

PRESSURE DROP and permeability

DN	Pressure Drop				Permeability at 100°C	
	(bar/m)				(g/year)	
	10 m ³ /h	20 m ³ /h	50 m ³ /h	100 m ³ /h	R134a	R407C
15	0,0054	0,0217			9	12
21	0,0012	0,0047			14	19
28		0,0015	0,009		23	32
38			0,002	0,0079	20	38
54			0,0003	0,0014	29	40

PRESSURE DROP

The values refer to actual tests performed using air

PERMEABILITY

The permeability value provides an indication of the maximum leakage tested at constant conditions of use of the hose at 100°C / 212°F for an entire year.

The real permeability value must therefore be measured considering the actual working time and temperatures to which the hose is subjected, keeping in mind that significant and detectable values are obtained with temperatures of more than 50°C / 122 °F and that the permeability increases proportionally to the temperature. The permeability values obtained at 100°C / 212°F for the GOMAX hose range, of approximately 1 kg/m²/year, are much lower than those set in the standard UNI EN 1736, which foresees a maximum permeability value of 5 kg/m²/year.

THERMOPLASTIC HOSE INSTALLATION FACTORS

THERMOPLASTIC HOSE INSTALLATION FACTORS

The specifications and particular conditions of use also determine the limits for the correct use of Gomax products. Accordingly, Transfer Oil can neither declare nor guarantee that any item will be suitable for a given applications: it is the business of users to apply their knowledge of the relevant details and carry out such tests as may be needed to ensure the selection of the item best suited for the particular requirements, eliminating risks to themselves, to the product, and to third parties. Users are strongly advised in their own interest, before making any final decision on the item, to consult the full range of information supplied in the Transfer Oil technical literature, catalogues and appendixes. To eliminate any element of doubt, the Transfer Oil sales department will obviously be at the customer's disposal to provide further information and respond to any request for clarification.

IMPORTANT NOTE FOR USERS

Hose assemblies require caution in use not only to provide long service life but also to guard against potentially dangerous failure. Serious injury, death and destruction of property can result from the rupture or blowing-apart of a hose assembly that is damaged, worn out, badly assembled or installed incorrectly. Users should follow good maintenance practices. Avoid expensive downtime by establishing a program of inspection, testing and replacement of hose assemblies before failure occurs: taking into account factors including: severity of application, frequency of equipment use, past performance of hose assemblies. Document your maintenance, inspections and testing. Only properly trained persons should inspect, test or service hose assemblies and this training should be updated regularly. Users should carefully observe the precautions listed below as well as following closely our recommendations for the selection of hose and couplings. In addition, care should be taken not to go below the minimum bend radius listed for each hose size and type. Maximum operating pressure and temperature should not exceed the pressures listed. Instruction for assembling fittings to different hoses should be followed carefully to ensure the safe performance of the complete assembly. By following the recommendations on hose assembly routing and installation, improved safety and longer service life of any hose installation will result. Gas and/or oil under pressure can be potentially dangerous! An explosive burst or stream of escaping gases or oils can cause damage to equipment as well as serious injury to persons nearby.

SALIENT INFORMATION

Highly pressurized gas and/or oil escaping from a small pinhole can be almost invisible and, yet, exert extreme force capable of penetrating the skin and other body tissues, causing possible severe injury. Hot gases / oils or chemicals can cause severe burns. Pressurized gases or oils, if released uncontrolled, can exert a tremendous explosive force. Some gas and/or oil are highly flammable.

PRECAUTIONS

Always position a shield between you and any pressurized lines when working next to them or shut the pressure off. Wear safety glasses. Do not use your hands to check for leaks. Do not touch a pressurized hose assembly with any part of your body, if fluid punctures the skin, even if no pain is felt, a serious emergency exists. Obtain medical assistance immediately. Failure to do so can result in loss of the injured body part or death. Stay out of hazardous areas while testing hose assemblies under pressure. Use proper safety protection. If an injury or reaction occurs, get medical attention right away. GOMAX hose and fitting (ZERO, INFINITY and QUADRA) are designed, engineered and tested to be used together in an assembly. The use of GOMAX fittings on other manufactures hose or the use of GOMAX hose with other manufactures fittings may result in the production of unreliable or unsafe assemblies. Hose (and hose assemblies) has a limited life dependent on service conditions to which it is applied. Subjecting hose (and hose assemblies) to conditions more severe than the recommended limits significantly reduce service life. Exposure to combinations of recommended limits (i.e. continuous use at maximum rated working pressure, maximum recommended operating temperature and minimum bend radius) will also reduce service life.

PRESSURE

After determining the system pressure for a system, hose selection must be made so that the recommended maximum operating pressure specified by a

given hose, is equal or greater than the maximum system pressure. Continuous use at maximum temperatures together with maximum pressures should always be avoided. Continuous use at or near the maximum temperature rating will cause a deterioration of physical properties of the tube and cover of most hose. This deterioration will reduce the service life of the hose. Pressure surges which exceed the maximum working pressure (pressure relief valve setting) affect the service life of system components, including a hose assembly and therefore need to be taken into consideration. Hoses used for suction lines must be selected to ensure the hose will withstand the potential negative pressure of the system.

BURST PRESSURE

These are test values only and apply to hose assemblies that have not been used and have been assembled for less than 30 days.

HIGH PRESSURE GAS

High pressure gaseous systems especially over 15 bar or 250 psi are very hazardous and should be adequately protected from external shock and mechanical or chemical damage. They should also be suitably protected to prevent whiplash action in the event of failure. TRANSFER OIL Thermoplastic hose is not recommended for high pressure pure oxygen charging applications.

TEMPERATURE

Care must be taken to ensure that the operating temperature of the gas and/or oil being conveyed and ambient temperatures do not exceed the limitations of the hose. Special care must be taken when routing near hot manifolds or molten metal.

INSULATION

Where the fittings of a QUADRA capillary hose can possibly be subject to permanent condensation or icing (for example on a suction line or an evaporator), we recommend to include the hose fitting within the insulation, in order to avoid unnecessary corrosion over time.

Insulate the capillary hose up to 5 cm (2 inches) from the end of the ferrule with a rubber type insulation hose or insulation tape.

GAS AND OILS COMPATIBILITY

Hose selection must assure compatibility of the hose tube, cover, reinforcement, and fittings with the gas and/or oil used. Additional caution must be observed in hose selection for gaseous applications. Some fire resistant fluids require the same hose as petroleum oil. Some use a special hose.

PERMEATION

Permeation (that is, seepage through the hose) will occur from inside the hose to outside when hose is used with gases, liquid and gas fuels, solvents and other media, and refrigerants (including but not limited to such materials such as helium, fuel oil, natural gas or refrigerant gas). This permeation may result in high concentrations of vapours which are potentially flammable, explosive, or toxic, and in loss of gas and/or oil. Even though the gas and/or oil compatibility is acceptable, you must take into account the fact that permeation will occur and could be hazardous. Permeation of moisture from outside the hose to inside the hose will also occur. If this moisture permeation would have detrimental effects (particularly but not limited to refrigeration and air conditioning systems), incorporation of sufficient drying capacity in the system or other appropriate system safeguards should be selected and used.

ROUTING

Attention must be given to optimum routing to minimise inherent problems. Restrain, protect or guide hose with the use of clamps if necessary to minimise risk or damage due to excessive flexing, whipping or contact with other moving parts or corrosives. Determine hose lengths and configurations that will result in proper routing and protection from abrasion, snagging or kinking and provide leak resistant connections.

ENVIRONMENT

Care must be taken to ensure that the hose and fittings are either compatible with or protected from the environment to which they are exposed. Environmental conditions including but not limited to ultraviolet light, heat, ozone, moisture, water, salt water, chemicals, and air pollutants can cause degradation and

premature failure and, therefore, must be considered.

REFRIGERANT GASES

Special care should be taken when working with refrigeration systems. Sudden escape of refrigerant gases can cause blindness if the escaping gases contact the eye and can cause freezing or other severe injuries if it contacts any other part of the body.

ATOMIC RADIATION

Atomic radiation affects all materials used in hose assemblies. Since the long-term effects may be unknown, do not expose hose assemblies to atomic radiation.

MECHANICAL LOADS

External forces can significantly reduce hose life. Mechanical loads which must be considered include excessive flexing, twist, kinking, tensile or side loads, bend radius, and vibration. Use of swivel type fittings or adaptors may be required to ensure no twist is put into the hose. Unusual applications may require special testing prior to hose selection.

EXTERNAL PRESSURE

In certain applications, such as in autoclaves or under water, the external environmental pressures may exceed the gas and/or oil pressure inside the hose. In these applications, consider the external pressures, and, if necessary, consult the manufacturers.

ABRASION

While a hose is designed with a reasonable level of abrasion resistance, care must be taken to protect the hose from excessive abrasion which can result in erosion, snagging, and cutting of the hose cover. Exposure of the reinforcement will significantly accelerate hose failure.

PROPER END FITTING

GOMAX hoses (QUADRA, INFINITY and ZERO) have been designed to be used exclusively with genuine GOMAX fittings, accessories and tools.

Using third party fittings, accessories or tools may cause malfunctioning of GOMAX hoses, with consequent risk of leakages of gas and/or oil, as well as damage to equipment and serious injury to persons nearby.

In the same way GOMAX fittings, accessories and tools are designed to be used exclusively with GOMAX hoses. Using GOMAX fittings, accessories and tools with third party hoses may cause malfunctioning, gas and/or oil leakages, as well as damage to equipment as well as serious injury to persons nearby.

HOSE-ASSEMBLY FABRICATION

Persons fabricating hose assemblies should be trained in the proper use of equipment and materials. The manufacturers' instructions must be followed. Properly assembled fittings are vital to the integrity of a hose assembly. Improperly assembled fittings can separate from the hose and may cause serious injury or property damage from whipping hose, or from fire or explosion of vapour expelled from the hose.

LENGTH

When establishing proper hose length, motion absorption, hose length changes due to pressure, as well as hose and machine tolerances must be considered.

SPECIFICATIONS AND STANDARDS

When selecting hose and fittings, government, industry and manufacturer's specifications and recommendations must be reviewed as applicable.

STATIC-ELECTRIC DISCHARGE

Gas and/or oil passing through hose can generate static electricity resulting in the possibility of static-electric discharge. This may create sparks that can puncture hose. If this potential exists, than adequate measures should be taken to insulate the product from potential earthing points that may contact the exterior surface of the hose.

MINIMUM BEND RADIUS

Installation of a hose at less than the minimum listed bend radius may significantly reduce the hose life. Particular attention must be given to avoid sharp bending at the hose/fitting juncture.

TWIST ANGLE AND ORIENTATION

Hose installations must be such that relative motion of machine components

does not produce twisting.

SECUREMENT

In many applications, it may be necessary to restrain, protect, or guide the hose to protect it from damage by unnecessary flexing, pressure surges, a contact with other mechanical components. Care must be taken to ensure such restraints do not introduce additional stress or wear points.

PROPER CONNECTION OF PORTS

Proper physical installation of the hose requires a correctly installed port connection while ensuring that no twist or torque is transferred to the hose.

EXTERNAL DAMAGE

Proper installation is not complete without ensuring that tensile loads, side loads, kinking, flattening, potential abrasion, thread damage, or damage to sealing surfaces are corrected or eliminated.

UNINTENDED USES

Hose assemblies are primarily designed for the internal forces of conducted gas and/or oil. Do not pull hose or use it for purposes that may apply external forces for which the hose or fittings were not designed.

HOSE AND FITTING MAINTENANCE INSTRUCTIONS

Even with proper selection and installation, hose life may be significantly reduced without a continuing maintenance program. Frequency should be determined by the severity of the application and risk potential. A maintenance program must be established and followed to include the following as a minimum:

VISUAL INSPECTION HOSE/FITTING

Any of the following conditions require immediate shut down and replacement of the hose assembly: Damaged, cut or abraded cover (any reinforcement exposed). Hard, stiff, heat cracked, or charred hose. Cracked, damaged, or badly corroded fittings. Leaks at the fitting or in the hose. Kinked, crushed, flattened or twisted hose. Blistered, soft, degraded, or loose cover.

VISUAL INSPECTION ALL OTHER

The following items must be tightened, repaired or replaced as required: Leaking port conditions. Clamp, guards, shields. System fluid level, fluid type and any air entrapment. Remove excess dirt build - up.

REPLACEMENT INTERVALS

Specific replacement intervals must be considered based on previous service life, government or industry recommendations, or when failures could result in unacceptable downtime, damage, or injury risk.

CORRECT ASSEMBLY INSTALLATION

Satisfactory performance and appearance depend upon proper hose installation. Excessive length destroys the trim appearance of an installation and adds unnecessarily to the cost of the equipment. Hose assemblies of insufficient length to permit adequate flexing, expansion or contraction will cause poor power transmission and shorten the life of the hose. The diagrams below offer suggestions for proper hose installations to obtain the maximum in performance and economy.

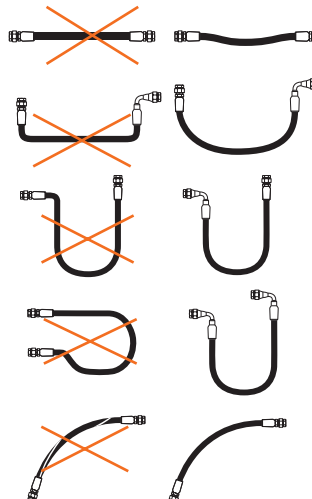

Since hose may change in length under the surge of high pressure, provide sufficient slack for expansion and contraction.

Hose should exit coupling in a straight position rather than side loaded. The minimum bend radius must not be exceeded to avoid kinking of hose and flow restriction.

Where the radius falls below the required minimum, an angle adapter should be used to avoid sharp bends in hose.

Avoid sharp twist or bend in hose by using proper angle adapters.

Hose is weakened when installed in twisted position. Also, pressure pulses in twisted hose tend to fatigue wire and loosen fitting connections. Design so that machine motion produces bending rather than torsion.

GENERAL TERMS OF SALE

General introduction

The following terms of sale will be applied to every contract concluded through a purchase order placed via the Internet, telefax, electronic mail and ordinary mail, and relating to the standard products listed in the site or in the Transfer Oil catalogues, at the appropriate page. Any different and specific terms and every order relating to personalised products may/must be the subject of a different, separate agreement. In the event of a contrast between these standard terms and any special term agreed to between the parties, the special term will take priority, but without prejudice to all the other general terms, as per the points below, wherever compatible. The general introduction forms an integral part of every purchase and sale contract concluded through the sending of the order form, whether by e-mail, by post or by telefax.

1. Preamble: Transfer Oil, hereafter also referred to as the Seller, sells the products listed and described in the "Products" page that can be found in official Transfer Oil web site or in one of the Transfer Oil catalogues, hereafter also referred to as the Products, which may be purchased under the terms as per the clauses below.

2. Conclusion of the contract. The purchase order on the Internet site must be compiled by the Purchaser according to the instructions in the appropriate "Orders" WEB page. The sending of the order form on the site, compiled as per the instructions, shall imply acceptance on the part of the purchaser of all the clauses outlined below. The sale and purchase contract, also in the event that the order is sent by the purchaser via telefax, e-mail or post, will in any case be considered as concluded and complete with the dispatch, on the part of Transfer Oil, of the due acceptance of the purchase order by telefax or electronic mail.

3. Cancellation and/or modification of orders. Penalty. Any cancellations, reductions and/or modifications of orders already accepted by Transfer Oil may be made within and not later than five days from the date of the order, by means of a written communication to be sent via fax or by registered letter with advice of receipt to the seller party. Any cancellation and/or modification notified after the above indicated period, or by other means different from those provided for in the previous paragraph shall imply a penalty of 10% of the price of the already ordered goods. The penalty referred to in the above paragraph will be invariably equal to 50% of the price should the object of the sale be personalised products according to the purchaser's wishes and requirements.

4. The Products. The Products that may be purchased, and the order of which implies - if accepted - total agreement with the general terms of sale, are those listed in the appropriate WEB page in the official Transfer Oil site, or in one of the Transfer Oil catalogues. The availability on stock of the above mentioned products is not guaranteed. In consideration of the particular applications of some products, the acceptance of the order can be subjected to a quantity equal to the economic batch of production in use at the moment of the order. In the event that the subject of the sale are personalised products according to the purchaser's wishes and requirements, having as a result different characteristics from standard products, these general terms of sale shall be equally applicable and binding, but without prejudice to any different, special condition that shall take priority should it be the subject of specific, separate agreement. Should the purchaser's offer or the seller's acceptance make reference to a specific sample, the product which is the subject of the relative sale, except in the event of a different written agreement, is binding with respect to the sample characteristics only within the limits of reasonable approximation.

5. Price and payment. The price shall be fixed according to the products chosen by the purchaser on the date of dispatch of the order and shall remain unchanged, except with reference to the provisions of the following clause, also if the delivery is deferred by agreement but nevertheless within six months from the date of the order. The customer has the right to the price relating to the products effectively collected with reference to that order for a period of six months. The seller has the right to revise the prices of the products on the basis of the price dynamics of raw materials, labour and packaging, but must notify the purchaser about new prices at least 30 days before their application, and in such cases, the purchaser has the right to withdrawal. Payment must categorically be made following the methods specified by Transfer Oil in the completed order form and according to the terms therein prescribed.

6. Express resolutive clause. In accordance and by the effects of art. 1456 of the civil code (c.c.), in the event of breach on the part of the purchaser of the obligations referred to in art. 5 (Price and payment), the seller shall have the right to cancel the contract/s already concluded, by means of a registered letter with advice of receipt, in which it declares to have made recourse to this clause, without prejudice, however, to any possible action for compensation for damages. Any change in the purchaser's balance sheet situation such as to endanger the correct fulfilment of the obligation of payment of the price, shall give the seller, in accordance with art. 1461 c.c., the right to suspend deliveries already agreed, and to cancel the contract by means of a simple written notice, without prejudice, however, to the payment of the amounts due for services already carried out. Equally, any incorrect or failed compliance with the obligations relating to the payment of the price shall give the seller the right to suspend deliveries already agreed, also those not relating to the breach in question, in accordance with art. 1460 c.c. It should be understood, in particular, that:

7. Delivery. The sale is considered as Ex-Works, and as a result, the costs of transport are fully borne by the purchaser. Transfer Oil shall arrange to deliver the Products sold to the carrier indicated by the purchaser in the order form.

8. Cancellation. The seller may cancel the contract and not fulfil the obligation to deliver whenever, by reason of force majeure and in any case of unforeseen and extraordinary events, the execution of the delivery service becomes excessively onerous or in any case impossible.

9. Quality. Transfer Oil carries out a random check of its products on each production batch. Any technical modifications will be subject to acceptance by the purchaser for orders in progress.

10. Warranty. Transfer Oil guarantees the conformity of the products supplied to the characteristics expressly indicated in the relative WEB page and in its catalogues. The warranty for defects in the products is categorically limited only to manufacture defects attributable to the seller. The warranty has a limited duration of twelve months, starting from the date of delivery, and is dependent on the regular reporting of the defect by the purchaser in accordance with the following paragraphs, as well as on the express written request to the seller to take action under the warranty. As a consequence of the aforementioned request, the seller may, at its own choice and alternatively: a) supply ex-works free of charge to the purchaser, products of the same type and quantity as those found to be defective or non-conforming to what was agreed; b) declare the cancellation of the contract in writing, offering the return of the price against restitution of the supplied products. Except in the event of malice or gross negligence on the part of the seller, any possible compensation for damages to the purchaser may not in any case exceed the invoice price for the disputed products. The warranty here agreed to assimilates and replaces legal guarantees for defects and deformities, and excludes any other liability on the part of Transfer Oil in any way arising from the supplied products: specifically, the purchaser may not make other requests for compensation for damages, a reduction in the price or the cancellation of the contract. Once the duration of the warranty has elapsed, no claim may be made against the seller. The seller may not be held liable with respect to the purchaser for any loss of profit, non-use, loss of production, loss of contracts or any other indirect or consequential damage, but only for proven damages to persons or things, attributable to the sold products, in the event of its proven gross negligence and/or incompetence in their manufacture.

11. Claims. Claims relating to quantity, colour, or to quality faults and defects or to non-conformity that the purchaser may detect as soon as they come into possession of the goods, must be made by the purchaser in writing by means of a registered letter with advice of receipt, on penalty of forfeiture, not later than eight days from the moment in which the products arrive at their place of destination. Should the claim turn out to be unfounded, the purchaser shall be bound to reimburse the seller all costs borne by the latter for carrying out checks (any travel costs, expert opinions, etc.).

12. Interpretations. Any reference made to general terms, list prices, various attachments or to other material of the seller or of third parties, must be considered as referring to the terms and documents applied upon the conclusion of the contract.

13. Applicable law and competent court. These General terms of Sale, together with the Contract to which they refer, shall be regulated by Italian laws. The Court of Parma shall be the exclusive competent court for any dispute relating to, or deriving from, the Contract.

Distributed by:

NTBL12



G O M A X[®]

a brand of

TRANSFER OIL

Transfer Oil S.p.A. - via sacca, 64 - 43052 - colorno (parma) - italy info@gomax.it - www.gomax.it