

One compressor, Two-stage work
Designed for high compression lift in
Low temperature and
Heat pump applications

LT Series Compound Two-stage Screw Compressor



Highlights of LT Series Screw Compressor

High-efficiency Two-stage design

- Pressure differential in each stage is smaller
- Less inner leakage and high volumetric efficiency
- More ECO injection flow creates better subcooling
- High displacement screw rotor profile
- Extended operation range and lower discharge temp.
- Fit the application with high initial suction pressure
- Working Evaporating Temp. as low as -65degC (-85degF)

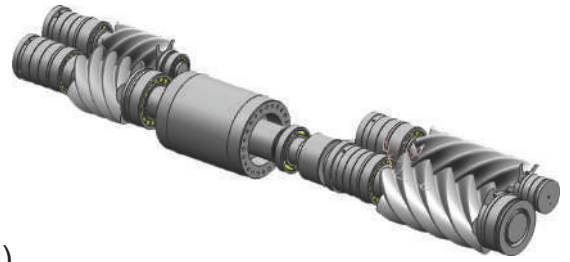

User-friendly Structure and Mechanism

- Step, Stepless and VFD capacity control options
- Easy start under minimum load with unloading-type slide valve in high stage
- Minimized rotor reversal time after compressor stop with suction check valve
- Low noise and vibration with built-in discharge muffler
- Dew-free cable box located at medium temperature section
- Less work space required compare to cascade system

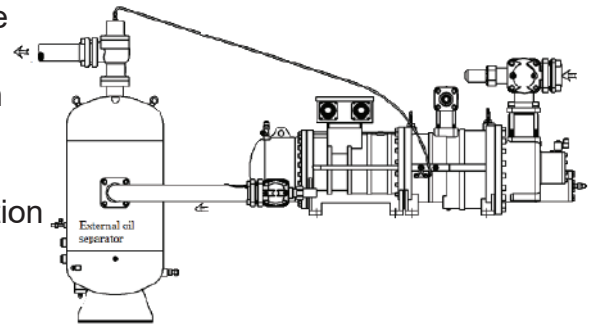

Complete Protection & Accessories

- Built-in motor temperature sensor PT100
- Motor and discharge side temperature thermistor
- Liquid injection to motor and to chamber for low- and high-stage
- Gas injection port in different connection side for easy piping and installation

Other Advantages

- Motor Winding designed in middle pressure section, refrigerant cooling and no frost during operation
- Minimum pressure valve (MPV) as standard, keep the pressure differential stable

Durable Bearing Structure

- High-quality radial and axial bearings
- Additional bearings for backward rotation
- α balance piston against axial thrust
- Heavy-duty design

Model Nomenclature

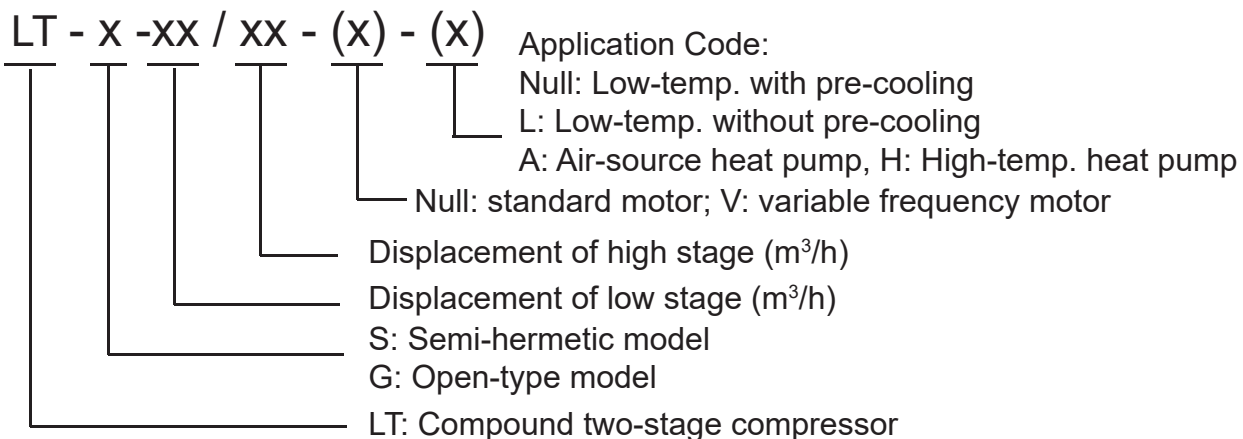

Technical Data

Low Temp. Model (LT-S: w/ pre-cooling, LT-S-L: w/o pre-cooling)

Model		LT-S-20/10	LT-S-30/12*	LT-S-45/20	LT-S-55/25	LT-S-65/32	LT-S-83/41	
Evaporating Temperature @ 100%		°C						R448A/ R449A/ R507/ R404A: -65°C to -25°C (LT-S) R448A/ R449A/ R507/ R404A: -65°C to -10°C (LT-S-L)
Compressor	Rated Speed (50Hz/60Hz)	rpm						2950/3550
	Displacement (Low stage)	m ³ /h	224/268	316/379	450/540	551/661	651/781	840/1008
	Displacement (High stage)	m ³ /h	99/119	137/164	207/248	257/308	313/375	396/475
	Capacity Control	%	10, 50, 100 (STEP TYPE) 10, 50~100 (STEPLESS TYPE)				10, 50, 75, 100 (STEP TYPE) 10, 50~100 (STEPLESS TYPE)	
	Lubrication		Pressure differential oil supply					
Motor	Type	3 phase, 2 pole, squirrel cage induction motor						
	Starter	Star-Delta, DOL						
	Voltage (50Hz)	V	380, 400, 415					
	Voltage (60Hz)	V	380, 440, 460, 480					
	Insulation		Class F					
	Protection		PTC+PT100					
Pressure Test	bar	35						
Noise Level (LT-S)	dB	80	81	83	84	86	87	
Noise Level (LT-S-L)	dB	81	NA	84	85	88	89	
Weight (LT-S)	kg	598	1158	1158	1195	1395	1430	
Weight (LT-S-L)	kg	620	NA	1200	1230	1450	1490	

*LT-S-30/12 is available on LT-S only

Air-source Heat Pump Model (LT-S-A)

Model		LT-S-20/10	LT-S-45/20	LT-S-55/25	LT-S-65/32	LT-S-83/41	
Evaporating Temperature @ 100%		°C					R448A/ R449A/ R507/ R404A: -65°C to 10°C R134a/ R513A/ R1234ze/ R1234yf: -45°C to 15°C
Compressor	Rated Speed (50Hz/60Hz)	rpm					2950/3550
	Displacement (Low stage)	m ³ /h	224/268	450/540	551/661	651/781	840/1008
	Displacement (High stage)	m ³ /h	99/119	207/248	257/308	313/375	396/475
	Capacity Control	%	10, 50, 100 (STEP TYPE) 10, 50~100 (STEPLESS TYPE)			10, 50, 75, 100 (STEP TYPE) 10, 50~100 (STEPLESS TYPE)	
	Lubrication		Pressure differential oil supply				
Motor	Type	3 phase, 2 pole, squirrel cage induction motor					
	Starter	Star-Delta, DOL					
	Voltage (50Hz)	V	380, 400, 415				
	Voltage (60Hz)	V	380, 440, 460, 480				
	Insulation		Class F				
	Protection		PTC+PT100				
Pressure Test	bar	40					
Noise Level	dB	81	83	84	86	87	
Weight	kg	620	1200	1230	1450	1490	

High Temp. Heat Pump Model (LT-S-H)

Model		LT-S-45/20	LT-S-55/25	LT-S-65/32	LT-S-83/41	
Condensing Temperature @ 100%		°C				R134a/ R513A/ R1234ze/ R1234yf: 35°C to 95°C
Compressor	Rated Speed (50Hz/60Hz)	rpm				2950/3550
	Displacement (Low stage)	m ³ /h	450/540	551/661	651/781	840/1008
	Displacement (High stage)	m ³ /h	207/248	257/308	313/375	396/475
	Capacity Control	%	10, 50, 100 (STEP TYPE) 10, 50~100 (STEPLESS TYPE)		10, 50, 75, 100 (STEP TYPE) 10, 50~100 (STEPLESS TYPE)	
	Lubrication		Pressure differential oil supply			
Motor	Type	3 phase, 2 pole, squirrel cage induction motor				
	Starter	Star-Delta, DOL				
	Voltage (50Hz)	V	380, 400, 415			
	Voltage (60Hz)	V	380, 440, 460, 480			
	Insulation		Class F			
	Protection		PTC+PT100			
Pressure Test	bar	45				
Noise Level	dB	84	85	88	89	
Weight	kg	1200	1230	1450	1490	

Application Limits (R448A/R449A/R507/R404A)

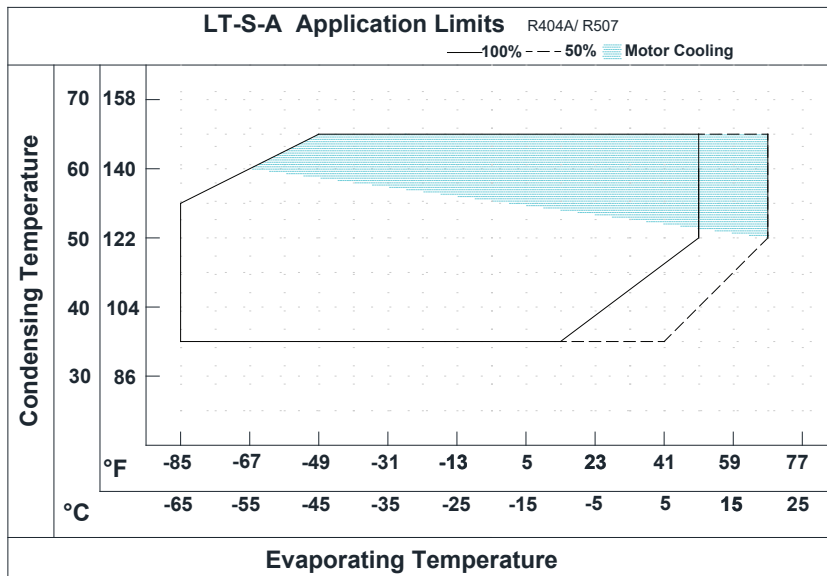
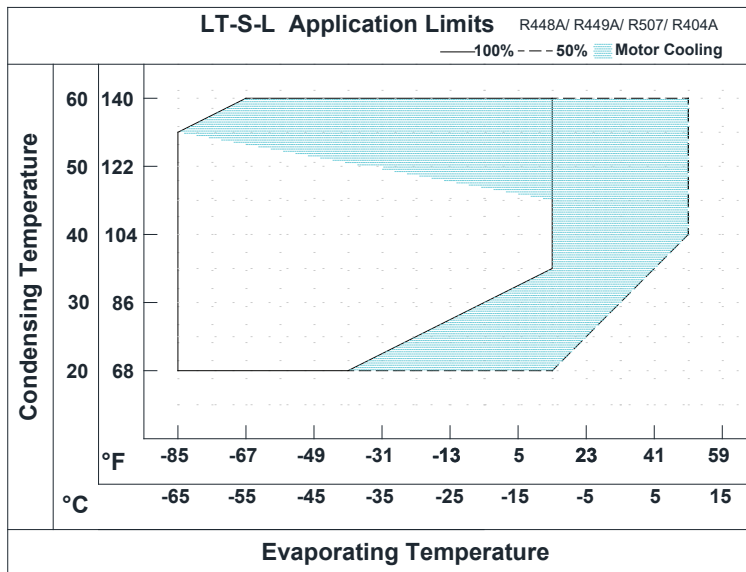
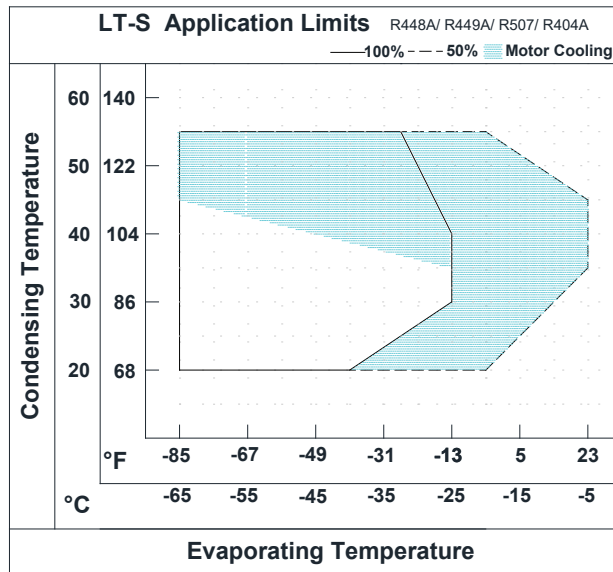

Application Limits (R134a/R513A)

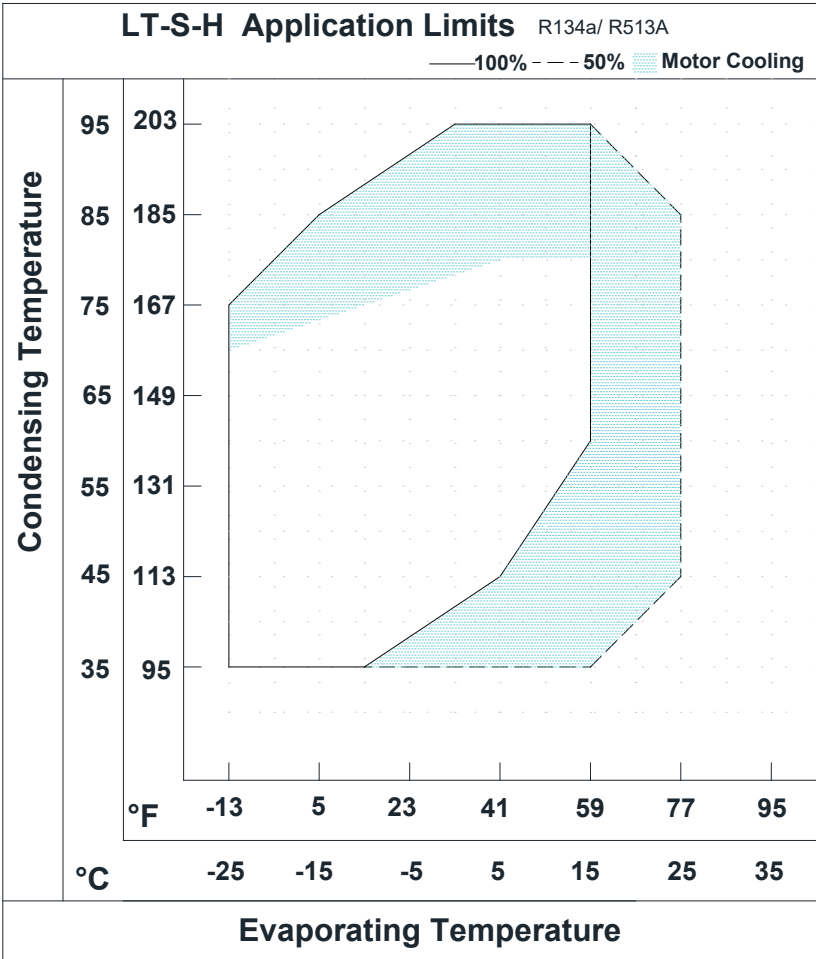
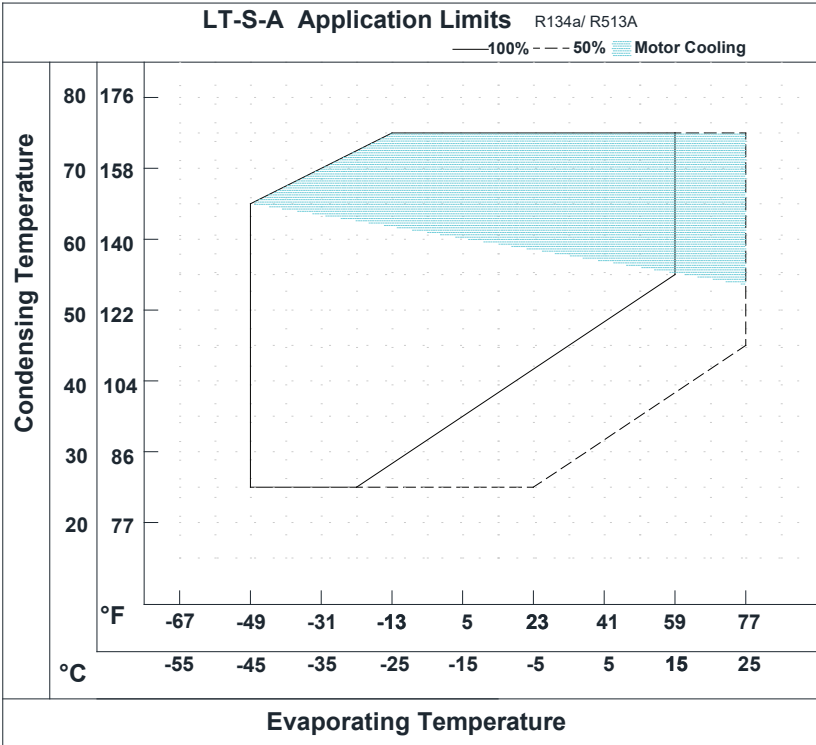

Application Limits (R1234ze/R1234yf)

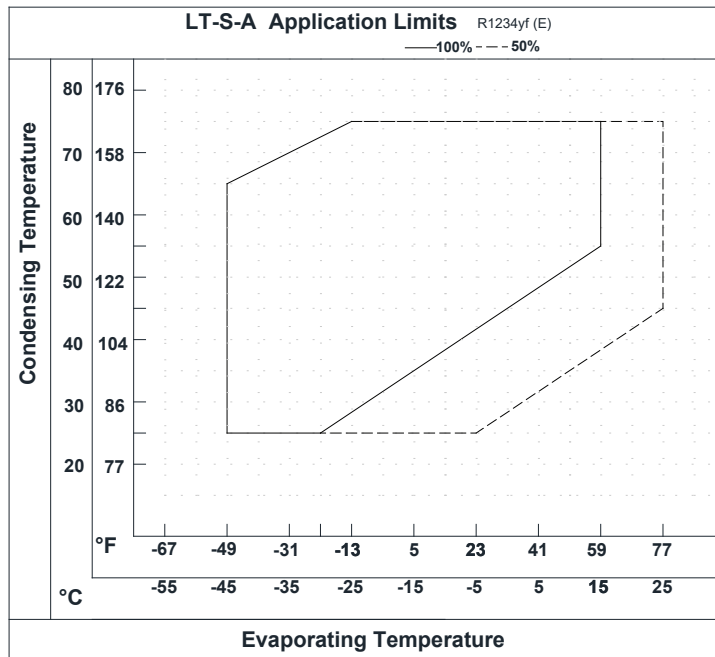
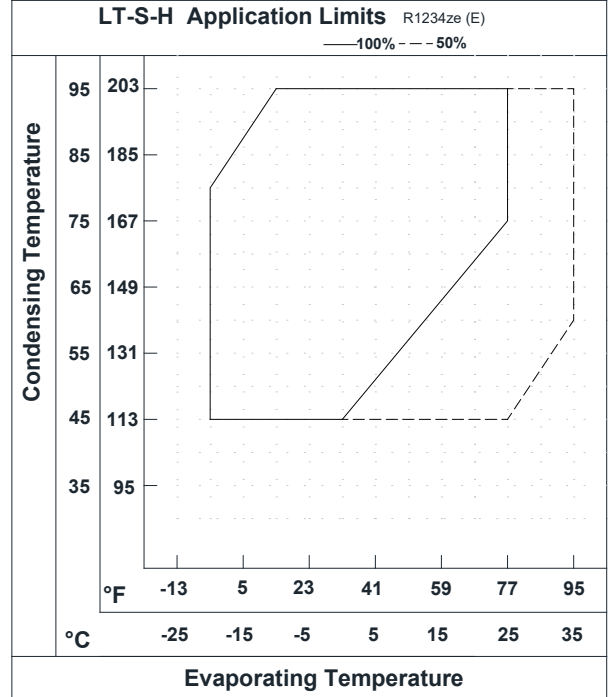
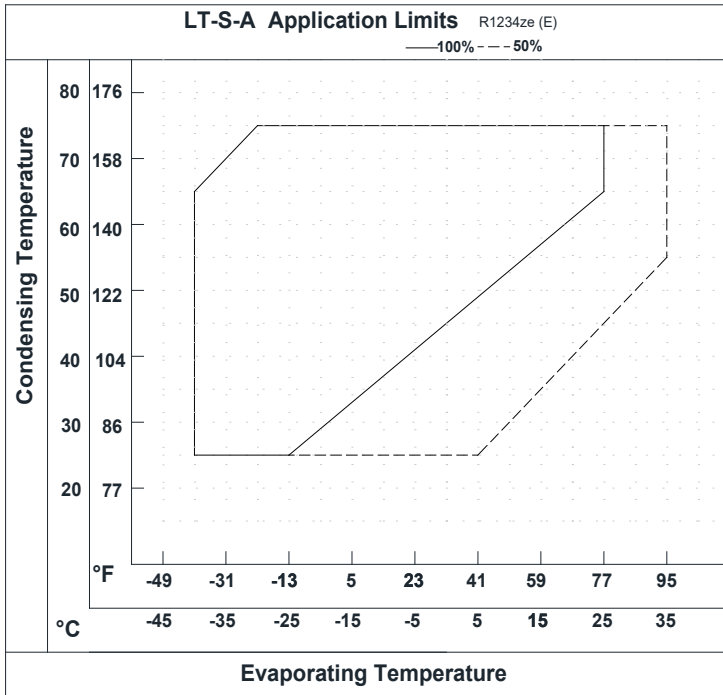

SHANGHAI HANBELL PRECISE MACHINERY CO., LTD

No.8289, Tingfeng RD, Fengjing Area, JinShan District, Shanghai
 TEL:+86-21-57350280 FAX:+86-21-57352004
<http://www.shahanbell.com.cn>
 E-mail:sales@shahanbell.com

HERMES VIET NAM MACHINERY COMPANY LTD

Block 28-30-32, 11 Street, Tan Duc Industrial Park, Commune, Duc Hoa District, Long An Province, Viet Nam.
 TEL: +84-72-3769688 FAX: +84-72-3769690

HANBELL KOREA

555-93, Baekseok-dong, Seobuk-gu, Cheonan-si, Chungcheongnam-do, Korea
 TEL:+82-41-562-5888 FAX:+82-41-562-5887
<http://hanbell.co.kr>
 E-mail:sales1@hanbell.com

HANBELL PRECISE MACHINERY CO., LTD.

NO.5 Kongsan Road, Kuan-Yin Industrial Park, Kuan-Yin District, Tao-Yuan City, Taiwan, R.O.C.
 TEL:+886-3-4836215 FAX:+886-3-4836223
<http://www.hanbell.com>
 E-mail:sales1@hanbell.com

HANBELL EUROPE

Via dei Campazzi 25 / 27, 21040 Gerenzano (VA), Italia
 TEL:+39-02-962-80188 FAX:+39-02-962-48011
<http://www.comer-srl.com>
 E-mail:sales.it@comer-srl.com

HANBELL MIDDLE EAST

FZJOA220, Jabel Ali, Dubai, UAE
 E-mail:sales1@hanbell.com



HBCE-LT-20-C(500)